

PROJECT	TYPE	CATALOG NUMBER
---------	------	----------------

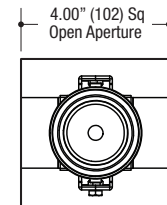
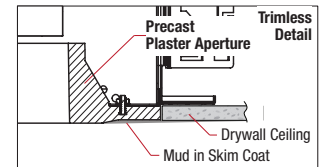
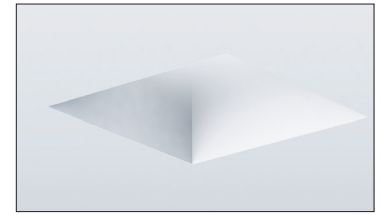
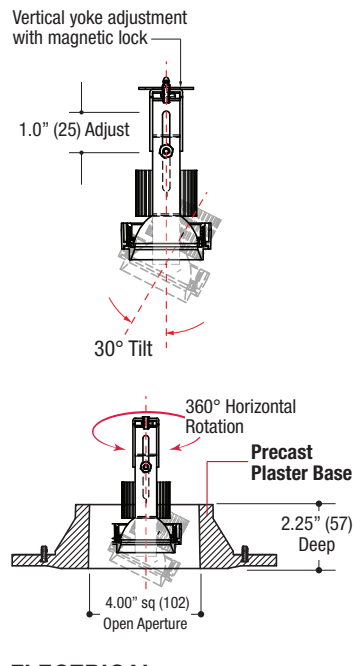
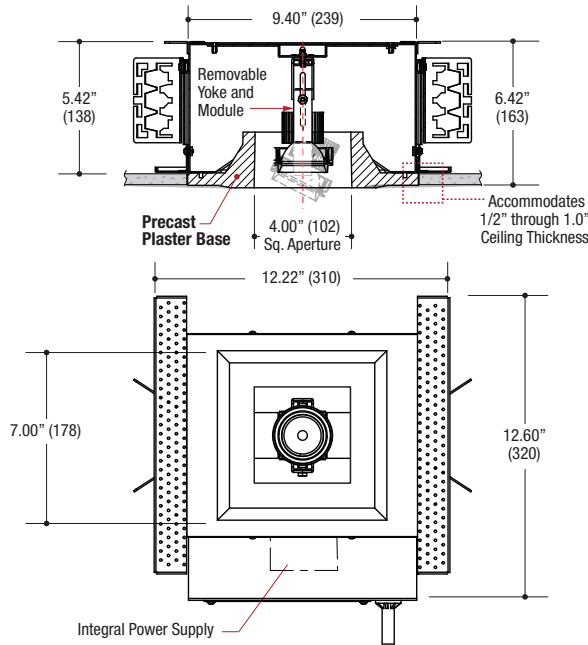

Specifications

SQUARE TRIMLESS DOWNLIGHT

- Housing of all steel construction
- White powder coat finish
- 4.00" square x 2.25" deep aperture of precast plaster
- **Ceiling Cut-out - 9.62" x 8.50"**

LED SOURCE - See wattage schedule below

- Bridgelux
- ValuDIM™
- CREE
- SORAA LED Optical Engine
- Accepts up to 2 or more optical accessories

ORDERING INFO

ELECTRICAL

- Field-replaceable integral LED driver
- Electrical wiring compartment integrated into housing construction
- Internal thermal protection
- Easy maintenance access through ceiling opening
- Rated for through-branch wiring
- Optional dimming

MOUNTING

- Butterfly brackets for commercial installation in drywall and other mud in ceiling types
- Perforated plate adjusts for 1/2", 5/8", 3/4" & 1.0" ceiling thickness
- Includes Heavy-Duty **L-Bars™** hanger bar system for residential installation

LABELS



- Suitable for damp location
- **IC rated / Air-Tight / Title 24 Compliant**

5 YEAR WARRANTY
Limited





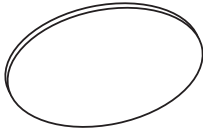
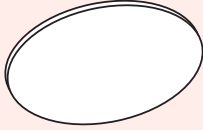
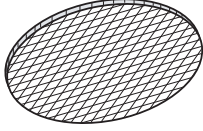

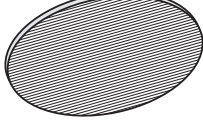
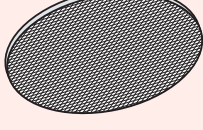
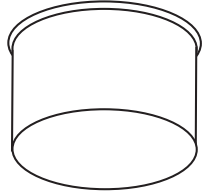

HOUSING SERIES	WATTAGE	CRI	COLOR	BEAM	MECHANISM	DRIVER	VOLTAGE	FINISH	OPTIONS
VF3S-1BA-S VF300 SERIES 4.00" Square Precast Plaster Trimless Aperture Adjustable Downlight New Construction Housing	Bridgelux 11L 11W LED (725lm) nom. 16L 16W LED (1065lm) nom.	80 80 CRI 90 90 CRI 97 97 CRI	27 2700K 30 3000K 35 3500K* 40 4000K* * 97 CRI n/a	N Narrow 20° M Medium 28° W Wide 40°	AD Adjustable	D1 Phase Dimming (120V only) D2 0-10V Dim. Driver (120-277V only)	1 120V U 120-277V	WW White	IC Insulated Ceiling (Rated 25W max.)
	ValuDIM™ 15V 15W LED (810lm) nom. 3000-2000K Warm Dimming	92 92 CRI	20 3000-2000K	N Narrow 17° M Medium 25° W Wide 38°					
	CREE 09C 09W LED (900lm) nom. 14C 14W LED (1200lm) nom. 20C 20W LED (1600lm) nom.	80 80 CRI 95 95 CRI	27 2700K 30 3000K 35 3500K 40 4000K	N Narrow 16° M Medium 28° W Wide 42°					
	SORAA Engine 07S 7W LED (650lm) nom. 10S 10W LED (800lm) nom.	80 80 CRI 95 95 CRI	27 2700K 30 3000K 40 4000K	N Narrow 9° (Snap-system compatible)					

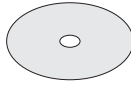
Order Example: **VF3S-1BA-S-16L-9027-W-AD-D2-U-MW-IC**

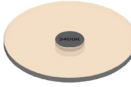
OPTICAL ACCESSORY	DESCRIPTION	LIGHT SOURCE
		SMALL
		<ul style="list-style-type: none"> • MR16 • CMHMR16 • 50mm LED
	Clear Lens	OPTB-CLR Ø2.00" (51mm) nom.
	Clear Lens - LED Film	OPTB-L-CLR Ø2.00" (51mm) nom.
	UV Lens	OPTB-UVL Ø2.00" (51mm) nom.
	Hex Cell Louver	OPTB-HXL Ø2.00" (51mm) nom.
	Diffusion Lens	OPTB-DFL Ø2.00" (51mm) nom.
	Diffusion Lens - LED Film	OPTB-L-DFL Ø2.00" (51mm) nom.
	Linear Spread Lens	OPTB-LSL Ø2.00" (51mm) nom.
	Linear Spread Lens - LED Film	OPTB-L-LSL Ø2.00" (51mm) nom.
	Prismatic Spread Lens	OPTB-PSL Ø2.00" (51mm) nom.
	Snoot - Black	OPTB-SNB Ø2.00" (51mm) nom.
	Snoot - White	OPTB-SNW Ø2.00" (51mm) nom.
	Snoot - Silver	OPTB-SNS Ø2.00" (51mm) nom.
	Snoot - White With Black Splay	OPTB-SNWB Ø2.00" (51mm) nom.
	Snoot - Silver With Black Splay	OPTB-SNSB Ø2.00" (51mm) nom.

* Other filters, colored glass, dichroics & micro-lenses available upon request

OPTICAL ACCESSORY	DESCRIPTION	07S and 10S	18S and 25S
		SORAA SMALL 7W & 10W	SORAA LARGE 18W & 25W
		<ul style="list-style-type: none"> • SLX16 • SNAP SYSTEM • SORAA® LED 	<ul style="list-style-type: none"> • SLX30 • SNAP SYSTEM • SORAA® LED
	Hex Cell Louver Louver Snap 40° Cutoff	OPTB-SLX16-HXL Ø2.00" (51mm) nom.	OPTD-SLX30-HXL Ø4.00" (102mm) nom.
	Diffusion Lens LED Film	OPTB-SLX16-L-DFL Ø2.00" (51mm) nom.	OPTD-SLX30-L-DFL Ø4.00" (102mm) nom.
	Linear Snap 10° x 25°	OPTB-SLX16-LSN Ø2.00" (51mm) nom.	N / A
	Linear Snap 10° x 36°	OPTB-SLX16-LSL Ø2.00" (51mm) nom.	OPTD-SLX30-LSL Ø4.00" (102mm) nom.
	Linear Snap 10° x 60°	OPTB-SLX16-LSW Ø2.00" (51mm) nom.	OPTD-SLX30-LSW Ø4.00" (102mm) nom.
	25° Beam Spreader Snap	OPTB-SLX16-MED25 Ø2.00" (51mm) nom.	OPTD-SLX30-MED25 Ø4.00" (102mm) nom.
	36° Beam Spreader Snap	OPTB-SLX16-WID36 Ø2.00" (51mm) nom.	OPTD-SLX30-WID36 Ø4.00" (102mm) nom.
	60° Beam Spreader Snap	OPTB-SLX16-VWD60 Ø2.00" (51mm) nom.	OPTD-SLX30-VWD60 Ø4.00" (102mm) nom.
	1/4 CTO CCT Shifter Snap	OPTB-SLX16-14CTO Ø2.00" (51mm) nom.	OPTD-SLX30-14CTO Ø4.00" (102mm) nom.
	1/2 CTO CCT Shifter Snap	OPTB-SLX16-12CTO Ø2.00" (51mm) nom.	OPTD-SLX30-12CTO Ø4.00" (102mm) nom.
	3/4 CTO CCT Shifter Snap	OPTB-SLX16-34CTO Ø2.00" (51mm) nom.	OPTD-SLX30-34CTO Ø4.00" (102mm) nom.
	Flat Top 25° x 25°	OPTB-SLX16-FT2 Ø2.00" (51mm) nom.	N / A
	Flat Top 36° x 36°	OPTB-SLX16-FT3 Ø2.00" (51mm) nom.	OPTD-SLX30-FT3 Ø4.00" (102mm) nom.
	Clear Lens	OPTB-SLX16-CLR Ø2.00" (51mm) nom.	OPTD-SLX30-CLR Ø4.00" (102mm) nom.
	Enhance Lens	OPTB-SLX16-ENH Ø2.00" (51mm) nom.	OPTD-SLX30-ENH Ø4.00" (102mm) nom.
	Aimable Lens	OPTB-SLX16-AIM Ø2.00" (51mm) nom.	OPTD-SLX30-AIM Ø4.00" (102mm) nom.