

PROJECT	TYPE	CATALOG NUMBER
---------	------	----------------

Measurements in () are metric equivalents.

8702 SQUARE BEVELED TRIMMED ACCENT - The VF150 Series is a large aperture, high efficiency family of products that meet and exceed the needs of today's lighting designers and specifiers that are seeking performance. Formed of die-cast aluminum.

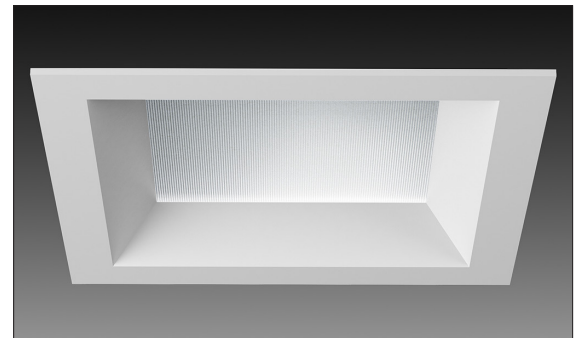
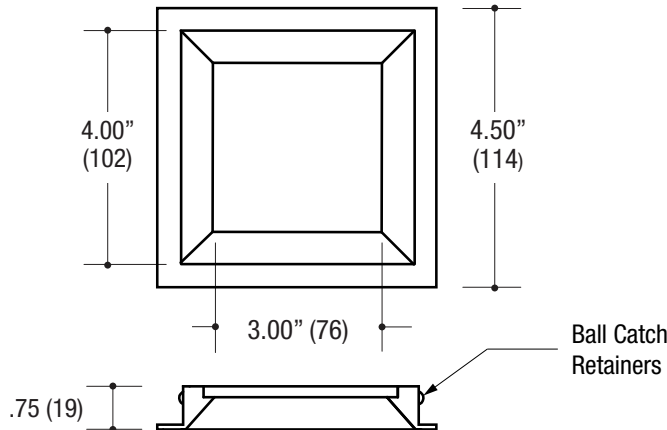

(Shown with lens)

Specifications

TRIM ORDERING INFO

TRIM SERIES	TRIM FINISH	LAY-IN LENS / FILM
8702	MW White MB Black XX Custom	CL Clear lay-in lens DF Diffused lay-in film DL Diffused lay-in lens SHCL Shower rated Clear lay-in lens SHDF Shower rated Diffused lay-in film SHDL Shower rated Diffused lay-in lens
4.50" Square Beveled Accent Die-Cast Aluminum Trimmed		

Example: **8702-MB-SHCL**

SQUARE BEVELED TRIMMED ACCENT

- Fixed or adjustable light output application
- 4.50" square die-cast aluminum
- 3.00" square large aperture
- .75" bevel regress
- .25" face trim
- Ball catch retainer for easy trim insertion and removal
- Safety cable included
- Powder coat finish

5 YEAR WARRANTY
Limited



HOUSING ORDERING INFO

SERIES	WATTAGE	CRI / COLOR	BEAM	HSG TYPE	DIMMING	VOLTAGE	OPTIONS
HVS-1BA-T Small Square Trimmed New Construction Housing	14R 14W LED 20R 20W LED	9018 90CRI LumaDIM™ 3000-1800K CT16 90CRI LumaTUNE™ 4000-1650K	N* Narrow 20° M Medium 40° W Wide 60° *Consult factory for accessories option	FD Fixed AD Adjustable	W1 0-10V (9018) 0-10V, Bluetooth or DMX (CT16) W4 EcoSystem Compatible (Remote DCA required-See accessory page for options) W5 EcoSystem Ready Integral 1 Channel DCA (9018) W6 EcoSystem Ready Integral 2 Channel DCA (CT16) W7 EcoSystem Ready Integral 4 Channel DCA (CT16)	U 120-277V	IC Insulated Ceiling EM Remotely Mounted Emergency LED Inverter
HVS-1BA-T							

Ordering Example: **HVS-1BA-T-14R-9018-M-AD-W1-U-EM**

Measurements in () are metric equivalents.



VF150 and LumaDIM™ together provide a whole new level of choice for light output with fully adjustable color control

LEDs have proven an effective source for many lighting applications. In the case of architectural lighting, accent and display applications have been the most widely used. Until now these designs have been limited to a single color temperature. Today, with greatly improved color quality and warm CCTs at high CRI levels, LEDs are now being used in hospitality and other areas where the effect of a "warm incandescent" type of lighting is needed. LumaDIM™ from LF Illumination can dim our VF100 LED products from a 3000K CCT at full brightness to 1800K at 1% of full range, and maintain a 90 CRI throughout, creating a warm output never before achievable with LED sources.

Specifications

SQUARE TRIMMED HOUSING

- Housing of all steel construction
- Adjustable plaster frame
- Black powder coat finish
- **Ceiling Cut-out - 4.25" X 4.25"**

LED TECHNOLOGIES

LumaDIM™ Warm dimming LED

- 14W / 600lm, 90CRI / 3000-1800K
- 20W / 900lm, 90CRI / 3000-1800K

[\(Click for more about LumaDIM™\)](#)



LumaTUNE™ Adjustable color tuning

- 14W / 600lm, 90CRI / 4000-1650K
- 20W / 900lm, 90CRI / 4000-1650K

[\(Click for more about LumaTUNE™\)](#)



Dimming

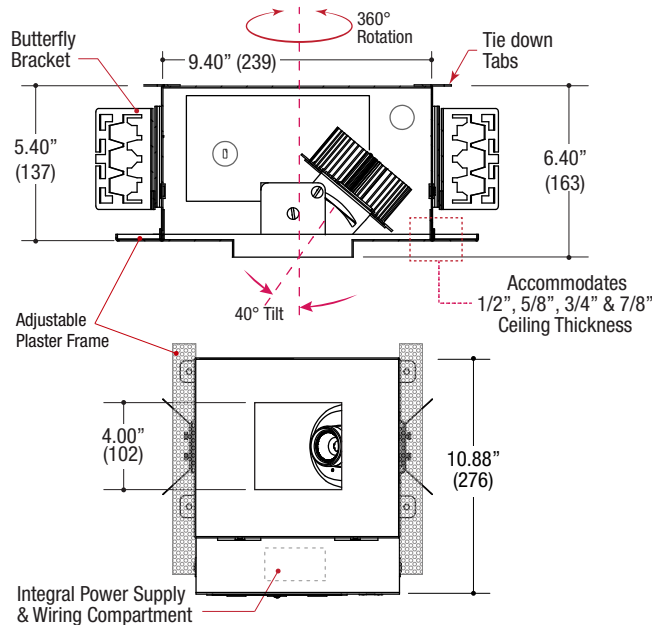

(HVS-1BA-T)

SMALL SIZED HOUSING

(AD) Adjustable Downlight

(FD) Fixed Downlight (Also available)



VF150 and LumaTUNE™ together provide a whole new level for white light technology, 100% - 1% tunable and dimmable

In the case of architectural lighting, the range of applications have been greater and specifications more demanding of LED technology. Typically these LED designs have been limited to a single color temperature.

LumaTUNE™ offers a tunable range of 1650-4000K at high CRI levels. Dimming to 1% with fixed CCT or Dimming to 1% with variable CCT to replicate halogen dimming profiles. Rather it be specification grade directional downlight, retail, accent, cosmetic-counters, hospitality or museums

LF Illumination's LumaTUNE™ offers greater versatility for the lighting designer's ever challenging demands.

ELECTRICAL

- Field-replaceable integral LED driver
- Electrical wiring compartment integrated into housing construction
- Internal thermal protection
- Easy maintenance access through ceiling opening
- Rated for through-branch wiring
- Optional dimming

MOUNTING

- Butterfly brackets for commercial installation in drywall, wood, stone, acoustic tile, or other ceiling types
- Perforated plate adjusts for 1/2", 5/8", 3/4" & 7/8" ceiling thickness
- Includes Heavy-Duty L-Bars™ hanger bar system for residential installation

LABELS

- Suitable for damp location, except when ordered with shower trim - Suitable for wet location
- **Air-Tight / IC Optional**

0-10V DIMMING COMPATIBILITY TABLE			
BRAND / MODEL	PART #	BRAND / MODEL	PART #
Lutron DIVA	DVSTV	Vantage INFUSION	LVOS-0-10-PWM-DIN
Lutron NOVA	NTFTV	Vantage INFUSION	LVOS-1-10-PWM-P
Lutron NOVA	NTTV	Crestron iLUX	CLS-EXP-DIMFLV
Lutron HWQS	LMJ-5T-DV-B	Crestron DIN	DIN-4DIMFLV4
Lutron POWPAK	RMJ-5T-DV-B	Crestron Green Light	GLX-DIMFLV8
Lutron Grafik Eye 3000	GRX-TVI	Crestron Green Light	GLXP-DIMFLV8
Lutron Grafik Eye 4000	GRX-TVI	Crestron DIN	DIN-A08
Lutron QS ENERGI SAVR	QNS-4T16-S		







(HVS-1BA-T)

SMALL SIZED HOUSING

5 YEAR WARRANTY
Limited

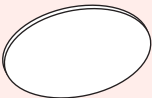
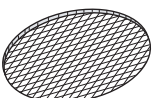

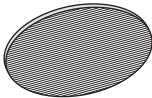
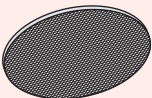
IC / Air-Tight

OPTICAL ACCESSORY	DESCRIPTION	LIGHT SOURCE
		• LED
	Clear Lens	OPTB-CLR Ø2.00" (51mm) nom.
	Clear Lens - LED Film	OPTB-L-CLR Ø2.00" (51mm) nom.
	UV Lens	OPTB-UVL Ø2.00" (51mm) nom.
	Hex Cell Louver	OPTB-HXL Ø2.00" (51mm) nom.
	Diffusion Lens	OPTB-DFL Ø2.00" (51mm) nom.
	Diffusion Lens - LED Film	OPTB-L-DFL Ø2.00" (51mm) nom.
	Linear Spread Lens	OPTB-LSL Ø2.00" (51mm) nom.
	Linear Spread Lens - LED Film	OPTB-L-LSL Ø2.00" (51mm) nom.
	Prismatic Spread Lens	OPTB-PSL Ø2.00" (51mm) nom.
	RACK-MOUNTED / Remote EcoSystem DCA 1-Channel For LumaDIM Dimming (9018)	LF-LTDCA1
	RACK-MOUNTED / Remote EcoSystem DCA 2-Channel For LumaTUNE Dimming & CCT Control (CT16)	LF-LTDCA2
	RACK-MOUNTED / Remote EcoSystem DCA 4-Channel For LumaTUNE Dimming & Full Color Control CCT, Saturation, CT & Intensity (CT16)	LF-LTDCA4

* Other filters, colored glass, dichroics & micro-lenses available upon request