

PROJECT	TYPE	CATALOG NUMBER
---------	------	----------------

Measurements in ( ) are metric equivalents.

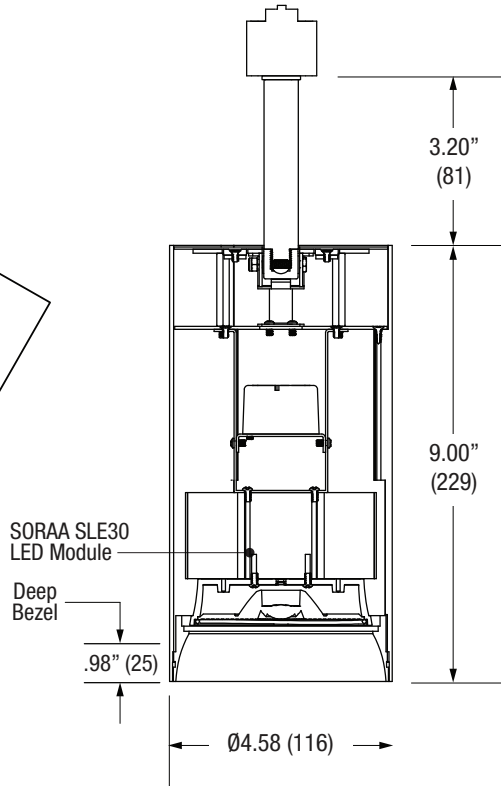

SORAA SLE30 LED Module  
Deep Bezel  
.98" (25)

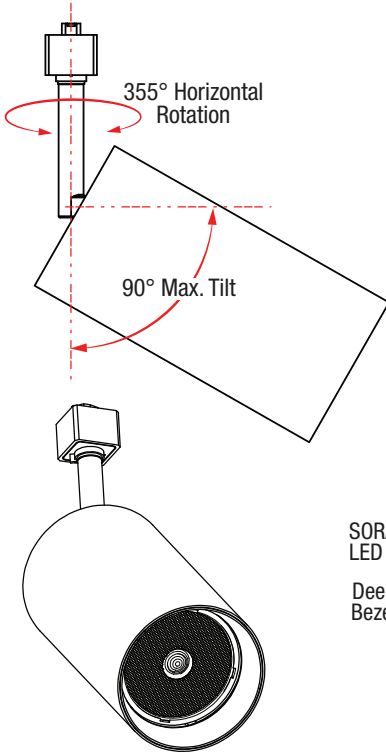
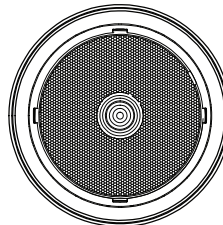

Bottom View

## Specifications

### MONOPOINT

- 4.58" diameter cylinder shaped trackhead
- 0.98" deep bezel
- 0°-90° vertical tilt
- 355° horizontal rotation
- Constant friction
- Die cast aluminum housing
- Powder coat finish

### SORAA LED MODULE

- 18W SORAA SLE Module 95CRI / 3000K
- 25W SORAA SLE Module 95CRI / 3000K
- SORAA Snap system optics compatible

### ELECTRICAL

- Integral LED driver
- Phase Dimmable

### MOUNTING

- Compatible with Halo®, Juno®, Global® GES track, Global® XTS track, Global® TEK track

### LABELS

- Suitable for dry location

### Track Adapters

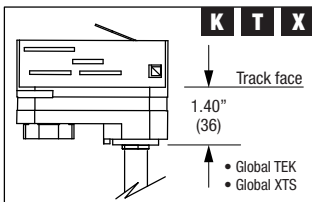
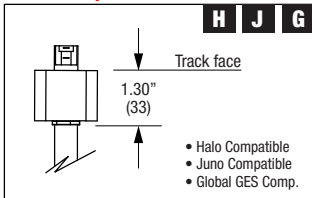

Halo® is a registered trademark of Cooper Industries,  
Juno® is a registered trademark of Juno Lighting,  
Global® is a registered trademark of Nordic Aluminium.









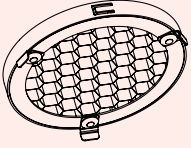
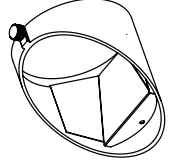
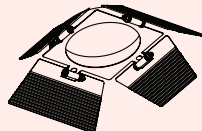
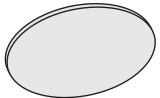
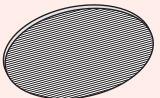

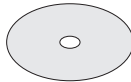
### ORDERING INFO

SERIES	ADAPTOR	LED MODULE	CRI / COLOR	BEAM	DRIVER / VOLTAGE	HSG FINISH	BEZEL FINISH
<b>TRA22D</b> <b>EMMA Series</b> <b>Cylinder Trackhead</b> Die Cast Aluminum Adjustable Aim	<b>H</b> Halo® compatible*	<b>18S</b> 18W LED ____ lm nom. <b>25S</b> 25W LED ____ lm nom. SLE 30 Module	<b>9530</b> 95CRI / 3000K	<b>N</b> Narrow 9°	<b>D11</b> Phase Dimmable @ 120V  <b>LD2</b> Non-Dimmable LED Driver @ 277V (K Adapter Only)	<b>W</b> White <b>B</b> Black <b>S</b> Silver	<b>W</b> White <b>B</b> Black <b>S</b> Silver
	<b>J</b> Juno® compatible*						
	<b>G</b> Global® GES compatible*						
	<b>T</b> Global® TEK compatible						
	<b>K</b> Global® HTEK compatible						
	<b>X</b> Global® XTS compatible						
	* One Circuit Compatible Only						
<b>TRA22D</b>							

Ordering Example: **TRA22-D-J-25S-N-9530-D11-W-S**

OPTICAL ACCESSORY	DESCRIPTION	EF208D / EF408D
		LED
	Hex Cell Louver - Black	OPT-EF208D-HXL
	Wallwash - White	OPT-EF208D-WWWW
	Wallwash - Black	OPT-EF208D-WWBB
	Barn Doors - White	OPT-EF208D-BDWW
	Barn Doors - Black	OPT-EF208D-BDBB
	Diffused Lens	OPT-EF208D-P-DFL
	Linear Spread Lens	OPT-EF208D-P-LSL

OPTICAL ACCESSORY	DESCRIPTION	<ul style="list-style-type: none"> <li>• PAR30</li> <li>• SNAP SYSTEM</li> <li>• SORAA® LED</li> </ul>
	Hex Cell Louver Louver Snap 40° Cutoff	OPTD-SLX30-HXL Ø4.00" (102mm) nom.
	Diffusion Lens LED Film	OPTD-SLX30-L-DFL Ø4.00" (102mm) nom.
	Linear Snap 10° x 36°	OPTD-SLX30-LSL Ø4.00" (102mm) nom.
	Linear Snap 10° x 60°	OPTD-SLX30-LSW Ø4.00" (102mm) nom.
	17° Beam Spreader Snap	OPTD-SLX30-NAR17 Ø4.00" (102mm) nom.
	25° Beam Spreader Snap	OPTD-SLX30-MED25 Ø4.00" (102mm) nom.
	36° Beam Spreader Snap	OPTD-SLX30-WID36 Ø4.00" (102mm) nom.
	60° Beam Spreader Snap	OPTD-SLX30-VWD60 Ø4.00" (102mm) nom.
	1/4 CTO CCT Shifter Snap	OPTD-SLX30-14CTO Ø4.00" (102mm) nom.
	1/2 CTO CCT Shifter Snap	OPTD-SLX30-12CTO Ø4.00" (102mm) nom.
	3/4 CTO CCT Shifter Snap	OPTD-SLX30-34CTO Ø4.00" (102mm) nom.
	Flat Top 36° x 36°	OPTD-SLX30-FT3 Ø4.00" (102mm) nom.
	Clear Lens	OPTD-SLX30-CLR Ø4.00" (102mm) nom.
	Enhance Lens	OPTD-SLX30-ENH Ø4.00" (102mm) nom.
	Aimable Lens	OPTD-SLX30-AIM Ø4.00" (102mm) nom.