

PROJECT	TYPE	CATALOG NUMBER
---------	------	----------------

Measurements in () are metric equivalents.

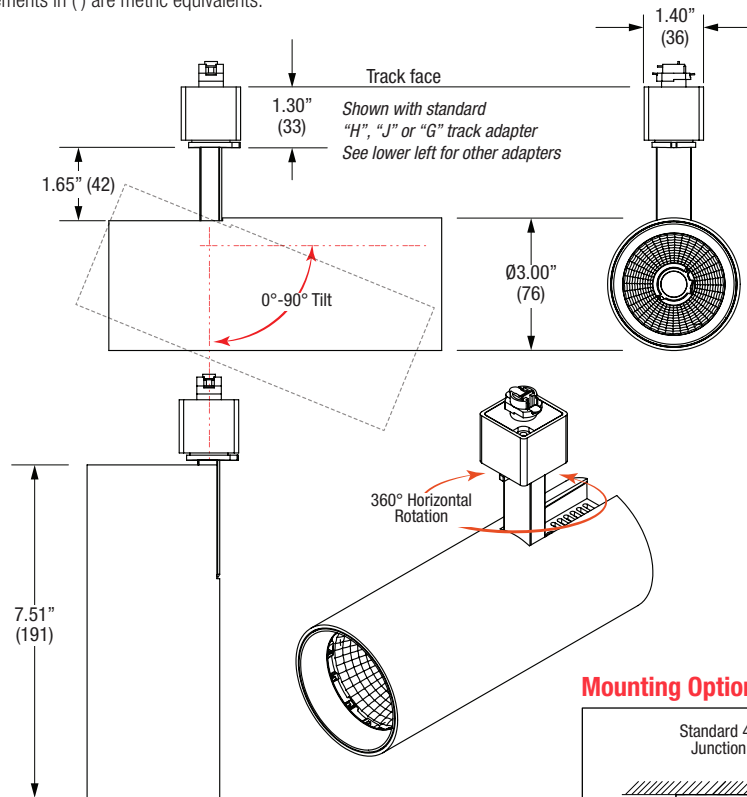

Specifications

TRACKHEAD

- 3.00" diameter cylinder shaped trackhead
- 0° - 90° vertical tilting / 360° horizontal rotation
- Constant friction
- Die cast aluminum housing
- LED optical grade reflector
- Powder coat finish

LED SOURCE

CREE

- ValuDIM™ Warm dimming
- Field replaceable optics available
- Will accept 1 additional media accessory
- Thru ventilation passively cooled thermal management

ELECTRICAL

- Fully integral LED driver
- Phase dimmable power supply

MOUNTING

- Compatible with Halo®, Juno®, Global® GES track, Global® XTS track, Global® TEK track, or Global® HTEK track
- Monopoint to J-box

LABELS

- Suitable for dry location

Mounting Option

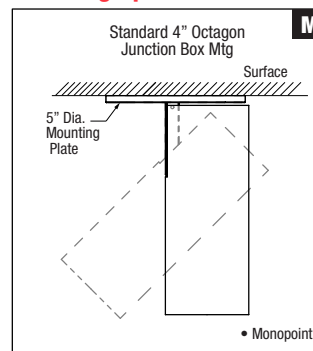

Track Adapters

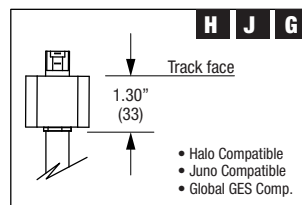
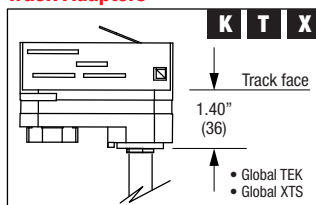

Halo® is a registered trademark of Cooper Industries,
Juno® is a registered trademark of Juno Lighting,
Global® is a registered trademark of Nordic Aluminium.

5 YEAR WARRANTY
Limited

ORDERING INFO

SERIES	ADAPTER	WATTAGE	CRI / COLOR	BEAM	POWER SUPPLY / VOLTAGE	FINISH
TRA20B LANIE Trackhead Die-Cast Aluminum Adjustable Aim	H Halo® compatible*	08C 08W LED 915 lm delivered	8027 80CRI / 2700K	N Narrow 13°	D11 Phase Dimming 120V	BB Matte Black
	J Juno® compatible*		8030 80CRI / 3000K	M Medium 25°	LD2 Non Dimming 277V (K adaptor only)	WW White
	G Global® GES compatible*	13C 13W LED 1231 lm delivered	8035 80CRI / 3500K	W Wide 36°	DMU Dimming Multiple Forward/Reverse Phase (@ 120V only) 0-10V Wires Present (@ 120-277V)	Consult factory for custom colors.
	T Global® TEK compatible*	19C 19W LED 1663 lm delivered	8040 80CRI / 4000K	V Very Wide 51°		
K Global® HTEK compatible**	26C 26W LED 2378 lm delivered	9227 92CRI / 2700K				
X Global® XTS compatible*		9230 92CRI / 3000K				
	M Monopoint***	@ 80CRI / 3000K Narrow Beam	9235 92CRI / 3500K			
	* D11 only ** LD2 only *** D11 or DMU	ValuDIM™ 15V 15W LED / 810 lm delivered 3000-2000K Warm Dimming	9240 92CRI / 4000K	ValuDIM™ N Narrow 17° M Medium 25° W Wide 38°		

Ordering Example: **TRA20B-T-26C-8030-N-D11-WW**

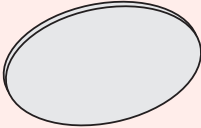
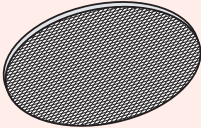
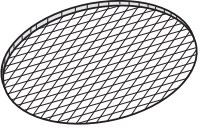
OPTICAL ACCESSORY	DESCRIPTION	LIGHT SOURCE
		SMALL
		• 65mm LED
	Diffusion Lens	OPT-TRA20B-P-DFL Ø2.60" (65mm) nom.
	Linear Spread Lens	OPT-TRA20B-P-LSL Ø2.60" (65mm) nom.
	Prismatic Spread Lens	OPT-TRA20B-P-PSL Ø2.60" (65mm) nom.
	Hex Cell Louver	OPT-TRA20B-HXL Ø2.60" (65mm) nom.

* Other filters, colored glass, dichroics & micro-lenses available upon request