

LED

INTEGRAL DRIVER

SMALL

|         |      |                |
|---------|------|----------------|
| PROJECT | TYPE | CATALOG NUMBER |
|---------|------|----------------|

Measurements in ( ) are metric equivalents.

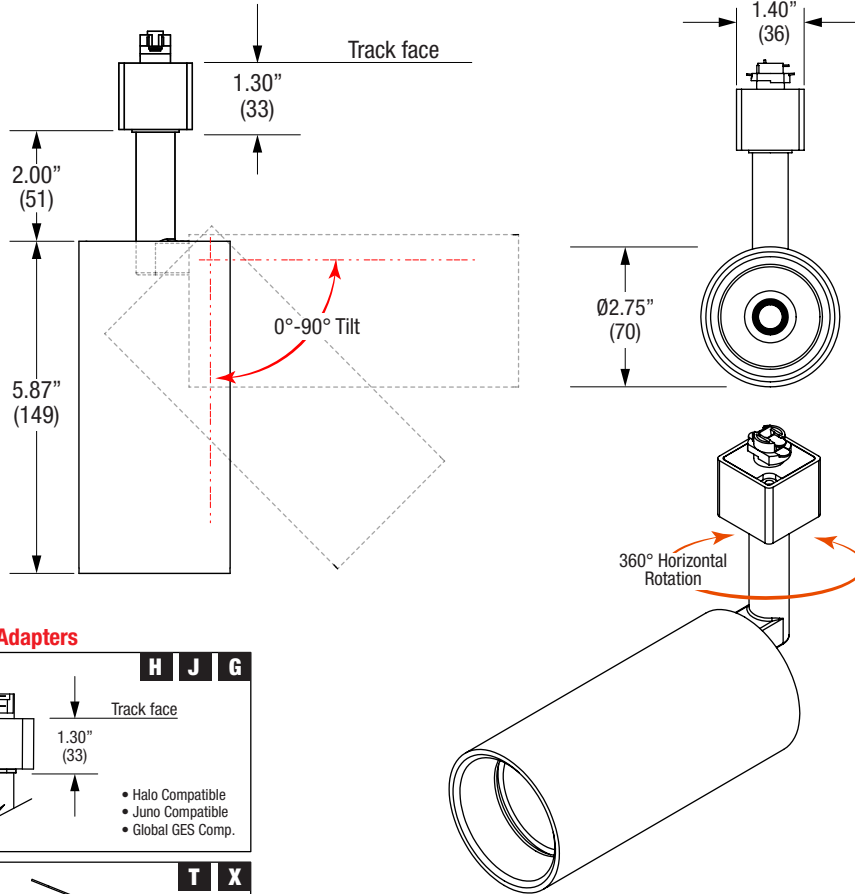

### Specifications

#### TRACKHEAD

- 2.75" diameter cylinder shaped trackhead
- 0° - 90° vertical tilting / 360° horizontal rotation
- Constant friction
- Die cast aluminum housing
- LED optical grade reflector
- Powder coat finish

#### LED SOURCE

- CREE 13W / 1152lm, (@ 80CRI / 3000K)
- ValuDIM™ Warm dimming
- Field replaceable optics available
- Will accept 1 additional media accessory

#### ELECTRICAL

- Fully integral LED driver
- Phase dimmable power supply

#### MOUNTING

- Compatible with Halo®, Juno®, Global®  
GES track, Global® XTS track,  
Global® TEK track

#### LABELS

- Suitable for dry location

#### Track Adapters

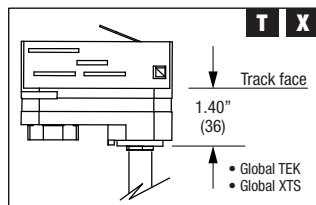
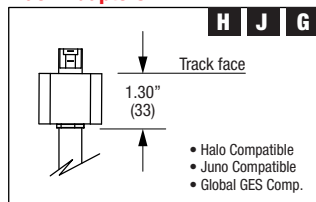

Halo® is a registered trademark of Cooper Industries,  
Juno® is a registered trademark of Juno Lighting,  
Global® is a registered trademark of Nordic Aluminium.



ValuDIM™



5 YEAR  
WARRANTY

Limited

#### ORDERING INFO

| SERIES  | ADAPTER   | WATTAGE  | CRI / COLOR  | BEAM  | POWER SUPPLY            | VOLTAGE       | FINISH   |
|---|---|--|--|---|-------------------------|---------------|--|
| <b>TRA19B</b><br><br>JULIE Trackhead<br>Die-Cast Aluminum<br>Adjustable Aim | <b>H</b> Halo® compatible<br><b>J</b> Juno® compatible<br><b>G</b> Global® GES compatible<br><b>T</b> Global® TEK compatible<br><b>X</b> Global® XTS compatible | <b>13C</b> 13W LED<br>1152lm delivered<br><br>Delivered @ 80CRI / 3000K<br>Narrow Beam                 | <b>8027</b> 80CRI / 2700K<br><b>8030</b> 80CRI / 3000K<br><b>8035</b> 80CRI / 3500K<br><b>8040</b> 80CRI / 4000K<br><b>9227</b> 92CRI / 2700K<br><b>9230</b> 92CRI / 3000K<br><b>9235</b> 92CRI / 3500K<br><b>9240</b> 92CRI / 4000K | <b>N</b> Narrow 12°<br><b>M</b> Medium 25°<br><b>W</b> Wide 34°<br><b>V</b> Very Wide 55° | <b>D1</b> Phase Dimming | <b>1</b> 120V | <b>BB</b> All Black<br><b>WB</b> White with Black Bezel<br><b>WW</b> All White<br><b>SB</b> Silver with Black Bezel<br><br>Consult factory for custom colors |
|   |   | <b>ValuDIM™</b><br><b>15V</b> 15W LED /<br>710lm delivered<br>Delivered @ 92CRI / 3000K<br>Narrow Beam | <b>9220</b><br>92CRI / 3000-2000K<br>Warm Dimming<br>(ValuDIM Only)  |   |                         |               |  |

Ordering Example: **TRA19B-H-13C-8030-M-D1-1-WW**

©2018 LF ILLUMINATION LLC

We reserve the right to change or withdraw specifications without prior notice.

HEADQUARTERS  
9200 Deering Avenue  
Chatsworth CA 91311

Telephone: 818-885-1335  
Toll Free: 855-885-1335  
Fax: 818-576-1335

www.lfillumination.com  
STD rev: 122018

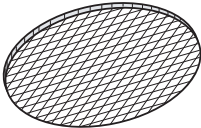
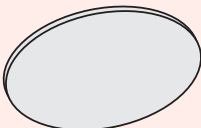
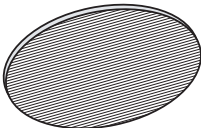
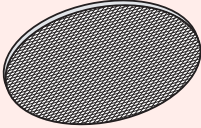
| OPTICAL ACCESSORY   | DESCRIPTION           | LIGHT SOURCE                           |
|---|-----------------------|--|
|   |                       | SMALL                                  |
|   |                       | • 60mm LED                             |
|    | Hex Cell Louver       | OPT-TRA19B-HXL<br>Ø2.36" (60mm) nom.   |
|    | Diffusion Lens        | OPT-TRA19B-P-DFL<br>Ø2.36" (60mm) nom. |
|    | Linear Spread Lens    | OPT-TRA19B-P-LSL<br>Ø2.36" (60mm) nom. |
|  | Prismatic Spread Lens | OPT-TRA19B-P-PSL<br>Ø2.36" (60mm) nom. |

\* Other filters, colored glass, dichroics & micro-lenses available upon request