

LED

INTEGRAL DRIVER

SMALL

PROJECT	TYPE	CATALOG NUMBER
---------	------	----------------

Measurements in () are metric equivalents.

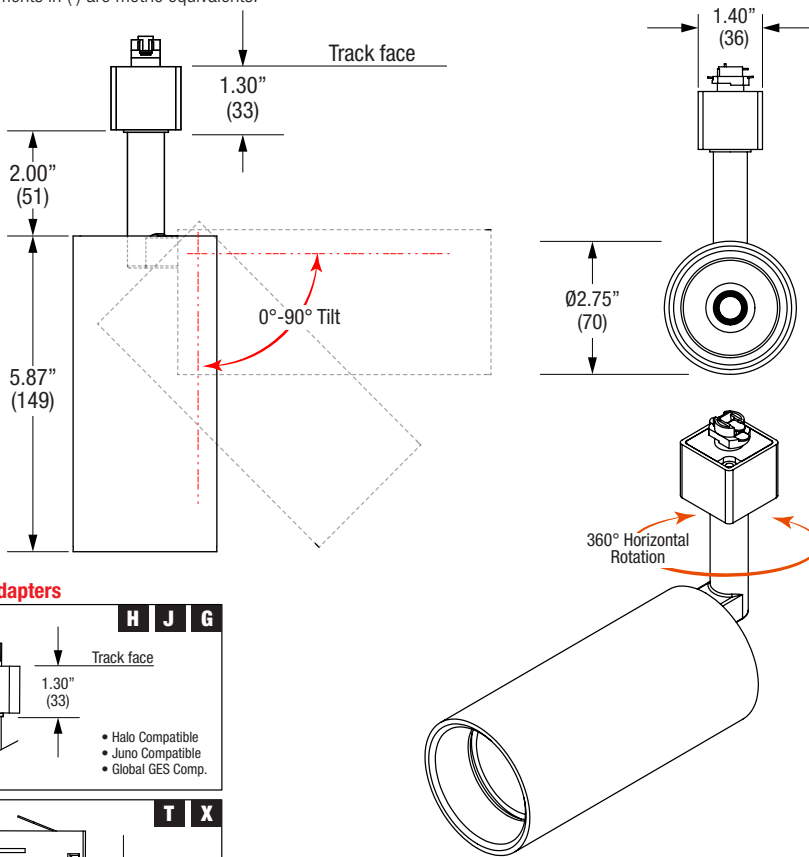

Specifications

TRACKHEAD

- 2.75" diameter cylinder shaped trackhead
- 0° - 90° vertical tilting / 360° horizontal rotation
- Constant friction
- Die cast aluminum housing
- LED optical grade reflector
- Powder coat finish

LED SOURCE

- CREE
- ValuDIM™ Warm dimming
- Field replaceable optics available
- Will accept 1 lens and 1 louver

ELECTRICAL

- Fully integral LED driver
- Phase dimmable (277V non-dimmable)

MOUNTING

- Compatible with Halo®, Juno®, Global® GES track, Global® XTS track, Global® TEK track, Global® HTEK track

LABELS

- Suitable for dry location

Track Adapters

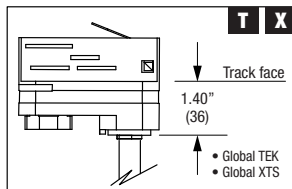
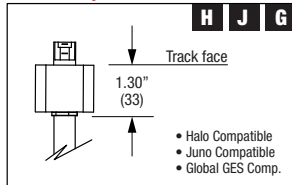

Halo® is a registered trademark of Cooper Industries,
Juno® is a registered trademark of Juno Lighting,
Global® is a registered trademark of Nordic Aluminium.



ORDERING INFO QuikShip In RED - 10 pc Minimum - Consult factory for quantities of 100 or more

SERIES	ADAPTER	WATTAGE	CRI / COLOR	BEAM	POWER SUPPLY	FINISH
TRA19B JULIE Trackhead Die-Cast Aluminum Adjustable Aim	H Halo® compatible*† J Juno® compatible* † G Global® GES compatible* † T Global® TEK compatible* K Global® HTEK compatible** X Global® XTS compatible*	08C 8W LED 801 lm del. 13C 13W LED 1078 lm del. 15C 15W LED 1208 lm del. Delivered @ 80CRI / 3000K Narrow Beam	8027 80CRI / 2700K 8030 80CRI / 3000K 8035 80CRI / 3500K 8040 80CRI / 4000K 9227 92CRI / 2700K 9230 92CRI / 3000K 9235 92CRI / 3500K 9240 92CRI / 4000K 9827 98CRI / 2700K 9830 98CRI / 3000K 9835 98CRI / 3500K 9840 98CRI / 4000K	N Narrow 12° M Medium 25° W Wide 34° V Very Wide 55°	D11 Phase Dimming 120V LD2 Non Dimming 277V (K adaptor only)	BB All Black WB White with Black Bezel WW All White SB Silver with Black Bezel Consult factory for custom colors
	* D11 only ** LD2 only † One Circuit Compatible Only	ValuDIM™ 15V 15W LED / 712lm del. / 3000-1800K Warm Dimming Delivered @ 92CRI / 3000K Narrow Beam	9220 92CRI / 3000-1800K Warm Dimming (ValuDIM Only)			

Ordering Example: **TRA19B-K-13C-8030-N-LD2-WW**

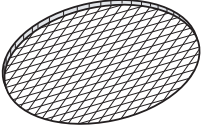
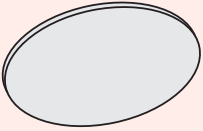
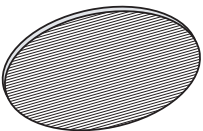
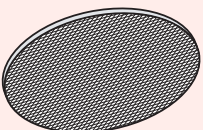
OPTICAL ACCESSORY	DESCRIPTION	LIGHT SOURCE
		SMALL
		• 60mm LED
	Hex Cell Louver	OPT-TRA19B-HXL Ø2.36" (60mm) nom.
	Diffusion Lens	OPT-TRA19B-P-DFL Ø2.36" (60mm) nom.
	Linear Spread Lens	OPT-TRA19B-P-LSL Ø2.36" (60mm) nom.
	Prismatic Spread Lens	OPT-TRA19B-P-PSL Ø2.36" (60mm) nom.

* Other filters, colored glass, dichroics & micro-lenses available upon request