

PROJECT	TYPE	CATALOG NUMBER
---------	------	----------------

CONFIG	A	B
11	12.01" (305)	5.46" (139)
12	16.15" (410)	5.46" (139)
13	27.97" (8710)	5.46" (139)
14	32.11" (816)	5.46" (139)
15	51.42" (1302)	5.46" (139)
16	55.38" (1407)	5.46" (139)
18	63.84" (1622)	5.46" (139)

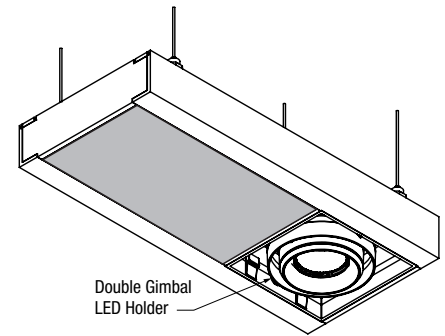
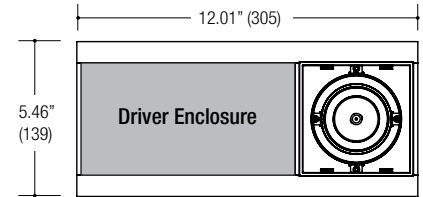
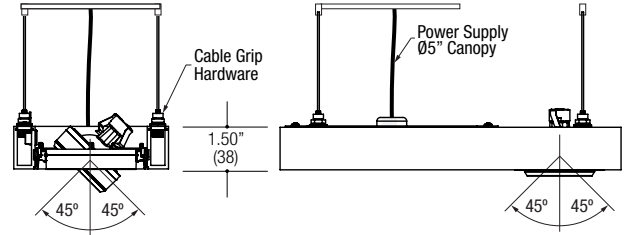
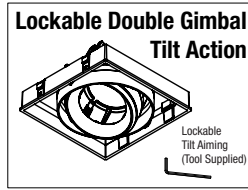
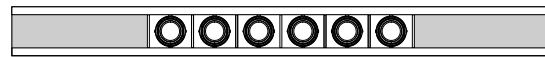
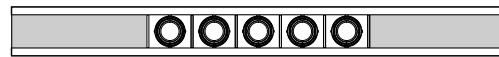
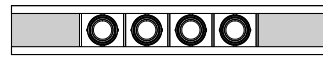
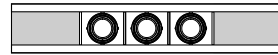
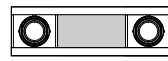
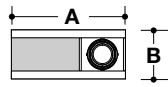

Measurements in ( ) are metric equivalents.

## Specifications

### CONSTRUCTION

- Horizontal surface-mount suspended ceiling fixture
- All aluminum construction with powder coat finish
- 1.50" x .75" extruded frame
- .188" thick aluminum cross blades
- Perforated power supply enclosure for cooler operating temperature
- Frame mounted double gimbal lamp source
- Lockable 45° x 45° tilt aiming
- Powder coat finish

### LAMPS (not included)

- 12V MR16 50W max - Derate Labels Available
- LED Retrofit 15W max - Works with SORAA®
- Accepts up to 2 or more optical accessories, dependent on lamp
- Powder coat finish

### ELECTRICAL

- Integral electronic transformer or metal halide ballast
- Electrical wiring compartment integrated into housing construction
- Thermal protection
- Easy maintenance access
- Dimmable (12V)

### MOUNTING

- Suspended ceiling mount
- 6' aircraft cable with cable grip hardware

### LABELS

- Suitable for damp location

### ORDERING INFO

SERIES	CONFIG	WATTAGE / LAMP	POWER SUPPLY	VOLTAGE	FINISH	OPTIONS
<b>PNH-B</b>  <b>SMALL</b> <b>SUSPENDED</b> <b>MULTIFORMS</b> Horizontal Suspension Ceiling Integral Power Supply	11	020MR16X MR16 20W	ET Electronic Transformer	1 120V 2 277V	BB Black WW White SS Silver XX Custom	EM Remotely Mounted Emergency LED Inverter (Intended for 1 light - Field wiring required)
	12	037MR16X MR16 37W				
	13	050MR16X MR16 50W				
	14	015MR16X MR16 15W				
	15	LED Retrofit				
	16					
	18					
<b>PNH-B</b>						

Ordering Example: **PNH-B-11-050MR16X-ET-1-BB-EM**

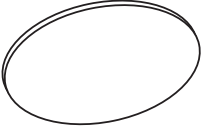
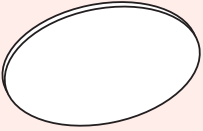
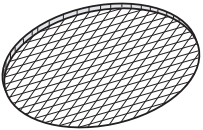
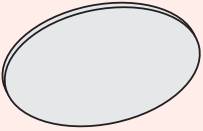
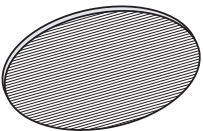
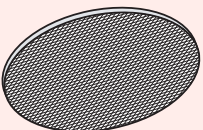
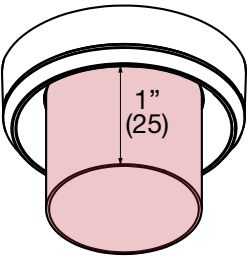

OPTICAL ACCESSORY	DESCRIPTION	LIGHT SOURCE
		SMALL
	Clear Lens	OPTB-CLR
	Clear Lens - LED Film	OPTB-L-CLR
	UV Lens	OPTB-UVL
	Hex Cell Louver	OPTB-HXL
	Diffusion Lens	OPTB-DFL
	Diffusion Lens - LED Film	OPTB-L-DFL
	Linear Spread Lens	OPTB-LSL
	Linear Spread Lens - LED Film	OPTB-L-LSL
	Prismatic Spread Lens	OPTB-PSL
	Snoot - Black	OPTB-SNB
	Snoot - White	OPTB-SNW
	Snoot - Silver	OPTB-SNS
	Snoot - White With Black Splay	OPTB-SNWB
	Snoot - Silver With Black Splay	OPTB-SNSB

\* Other filters, colored glass, dichroics & micro-lenses available upon request