

TRIMMED

LED

MEDIUM

PROJECT

TYPE

CATALOG NUMBER

Measurements in () are metric equivalents.

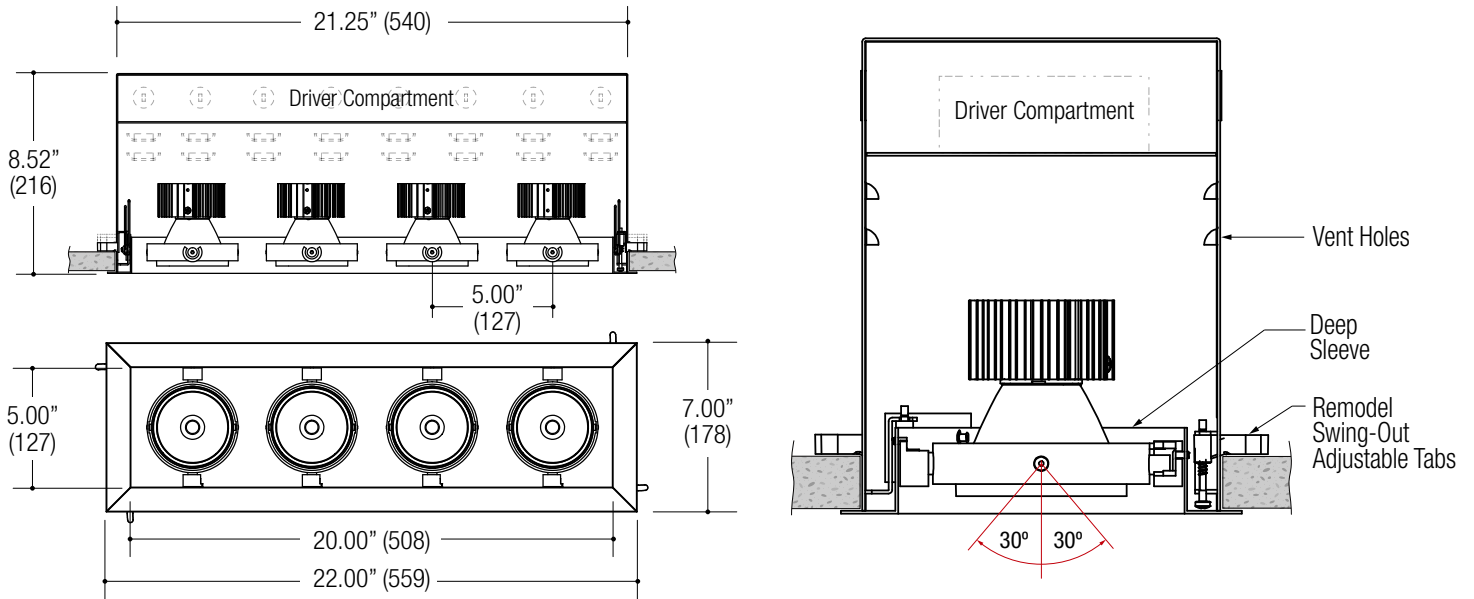

DESCRIPTION

- Four light recessed accent / downlight - medium size
- All steel 18GA construction remodel housing
- 1" trim flange with 5.00" x 20.00" open aperture
- Vent holes for cooler operating temperature
- Deep sleeve feature to conceal inner components
- Powder coat finish
- **Ceiling Cut-Out - 6.70" x 21.25" Important! No Larger**

LED SOURCE

- Field-replaceable integral LED module
- Field-changeable optic
- 17W / 1700lm (@ 80CRI min / 3000K)
- 22W / 2200lm (@ 80CRI min / 3000K)
- Accepts up to 2 or more optical accessories
- Trim mounted double gimbal
- 30° x 30° tilt aiming

ELECTRICAL

- Field-replaceable integral LED driver
- Electrical wiring compartment integrated into housing construction
- Thermal protection
- Easy maintenance access through ceiling opening
- Rated for through-branch wiring
- Dimmable

MOUNTING

- Trim collar is secured using adjustable swing out tabs
- For installation in drywall, wood, stone, acoustic tile, or other ceiling types
- Adjust for 1/2" through 1.0" ceiling thickness

LABELS

- Suitable for damp location

5 YEAR WARRANTY
Limited



ORDERING INFO

SERIES	WATTAGE	CRI / COLOR	BEAM	LAMP ASSEMBLY	DRIVER	VOLTAGE	FINISH	OPTIONS
MF34CR-T MULTIFORMS REMODEL MF300 Series Recessed 4-Light Adjustable Accent Trimmed Fixture Remodel Housing	17L 17W LED 1700 lm nom.	8027 80CRI / 2700K	N	TD Trim Mounted Double Gimbal	D1 Phase Dimming (120V only) D2 0-10V Dimming D3 Lutron Hi-lume™* Forward Phase (120V only) D4 Lutron Hi-lume™* EcoSystem™ & 3 wire (1%) DE Lutron Hi-lume™* EcoSystem™ 1% with Soft-On, Fade-to-Black™ *Consult factory for further dimming options	1 120V U 120-277V	BB Black WW White WB White Trim / Black Interior SS Silver SB Silver Trim / Black Interior XX Custom	EM Remotely Mounted Emergency LED Inverter
		8030 80CRI / 3000K	Narrow 22°					
		8035 80CRI / 3500K	M					
	22L 22W LED 2200 lm nom.	8040 80CRI / 4000K	M	Medium 43°				
		9027 90CRI / 2700K	W	Wide 58°				
		9030 90CRI / 3000K						
		9727 97CRI / 2700K						
		9730 97CRI / 3000K						
MF34CR-T								

Ordering Example: **MF34CR-T-22L-8027-N-TD-D2-U-BB-EM**

©2016 LF ILLUMINATION LLC

We reserve the right to change or withdraw specifications without prior notice.

HEADQUARTERS
9200 Deering Avenue
Chatsworth CA 91311

Telephone: 818-885-1335
Toll Free: 855-885-1335
Fax: 818-576-1335

www.lfillumination.com
rev: 093016

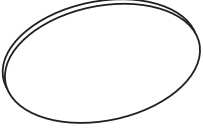
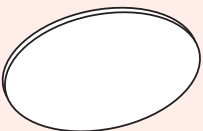
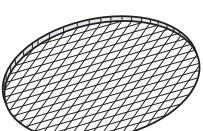
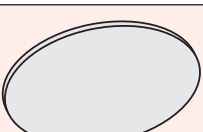
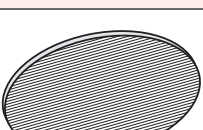
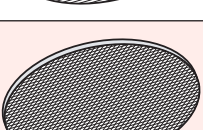
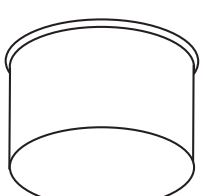
OPTICAL ACCESSORY	DESCRIPTION	LIGHT SOURCE		
		SMALL	MEDIUM	LARGE
		<ul style="list-style-type: none"> • MR16 • CMHMR16 • 50mm LED 	<ul style="list-style-type: none"> • PAR20 • PAR20CMH • T4GU6.5 • 70mm LED 	<ul style="list-style-type: none"> • PAR30 / PAR30CMH • T4G8.5 • T6G12 • AR111 / CDMR111 • 111mm LED
	Clear Lens	OPTB-CLR Ø2.00" (51mm) nom.	OPTC-CLR Ø2.90" (74mm) nom.	OPTD-CLR Ø4.40" (112mm) nom.
	Clear Lens - LED Film	OPTB-L-CLR Ø2.00" (51mm) nom.	N/A	N/A
	UV Lens	OPTB-UVL Ø2.00" (51mm) nom.	OPTC-UVL Ø2.90" (74mm) nom.	OPTD-UVL Ø4.40" (112mm) nom.
	Hex Cell Louver	OPTB-HXL Ø2.00" (51mm) nom.	OPTC-HXL Ø2.90" (74mm) nom.	OPTD-HXL Ø4.40" (112mm) nom.
	Diffusion Lens	OPTB-DFL Ø2.00" (51mm) nom.	OPTC-DFL Ø2.90" (74mm) nom.	OPTD-DFL Ø4.40" (112mm) nom.
	Diffusion Lens - LED Film	OPTB-L-DFL Ø2.00" (51mm) nom.	OPTC-L-DFL Ø2.90" (74mm) nom.	OPTD-L-DFL Ø4.40" (112mm) nom.
	Linear Spread Lens	OPTB-LSL Ø2.00" (51mm) nom.	OPTC-LSL Ø2.90" (74mm) nom.	OPTD-LSL Ø4.40" (112mm) nom.
	Linear Spread Lens - LED Film	OPTB-L-LSL Ø2.00" (51mm) nom.	OPTC-L-LSL Ø2.90" (74mm) nom.	OPTD-L-LSL Ø4.40" (112mm) nom.
	Prismatic Spread Lens	OPTB-PSL Ø2.00" (51mm) nom.	OPTC-PSL Ø2.90" (74mm) nom.	OPTD-PSL Ø4.40" (112mm) nom.
	Snoot - Black	OPTB-SNB Ø2.00" (51mm) nom.	OPTC-SNB Ø2.90" (74mm) nom.	OPTD-SNB Ø4.40" (112mm) nom.
	Snoot - White	OPTB-SNW Ø2.00" (51mm) nom.	OPTC-SNW Ø2.90" (74mm) nom.	OPTD-SNW Ø4.40" (112mm) nom.
	Snoot - Silver	OPTB-SNS Ø2.00" (51mm) nom.	OPTC-SNS Ø2.90" (74mm) nom.	OPTD-SNS Ø4.40" (112mm) nom.
	Snoot - White With Black Splay	OPTB-SNWB Ø2.00" (51mm) nom.	OPTC-SNWB Ø2.90" (74mm) nom.	OPTD-SNWB Ø4.40" (112mm) nom.
	Snoot - Silver With Black Splay	OPTB-SNSB Ø2.00" (51mm) nom.	OPTC-SNSB Ø2.90" (74mm) nom.	OPTD-SNSB Ø4.40" (112mm) nom.

* Other filters, colored glass, dichroics & micro-lenses available upon request