

PROJECT	TYPE	CATALOG NUMBER
---------	------	----------------

Measurements in () are metric equivalents.

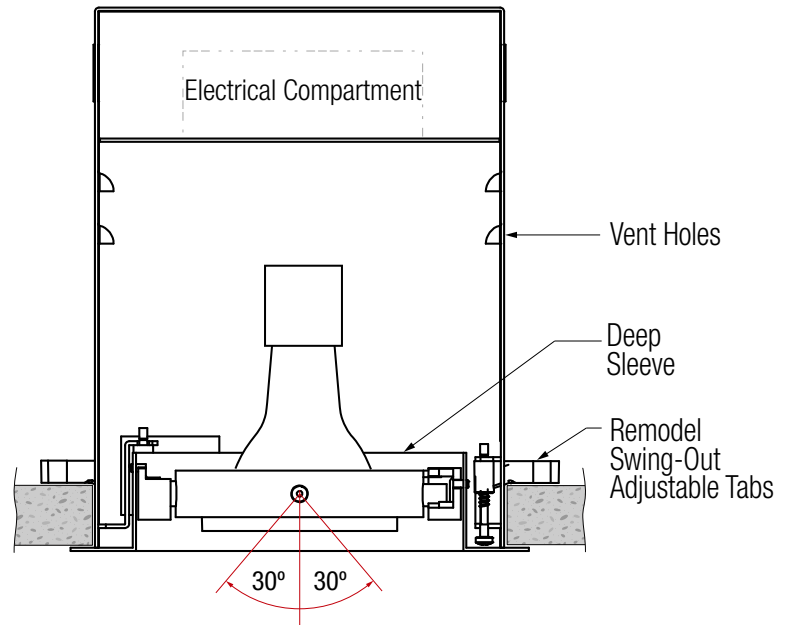
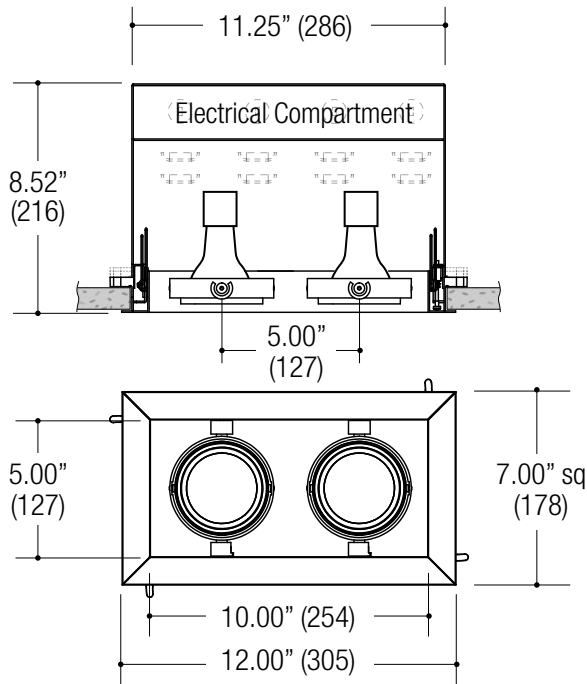

DESCRIPTION

- Two light recessed accent / downlight - medium size
- All steel 18GA construction with powder coat finish
- 1" Trim flange with 5.00" x 10.00" open aperture
- Trim flange removable for maintenance
- Vent holes for cooler operating temperature
- Deep sleeve to conceal inner components
- **Ceiling Cut-Out - 6.70" x 11.25" Important! No Larger**

LAMPS (not included)

- 120V PAR20 Halogen 50W max - Derate Labels Available
- PAR20MH 20W or 39W
- Accepts up to 2 or more optical accessories, dependent on lamp
- Trim mounted double gimbal
- 30° x 30° tilt aiming

ELECTRICAL

- Integral metal halide ballast (no power supply for line voltage lamps)
- Electrical wiring compartment integrated into housing construction
- Thermal protection
- Easy maintenance access through ceiling opening
- Rated for through-branch wiring
- Dimmable (line voltage only)

MOUNTING

- Trim collar is secured using adjustable swing out tabs
- For installation in drywall, wood, stone, acoustic tile, or other ceiling types
- Adjust for 1/2" through 1.0" ceiling thickness

LABELS

- Suitable for damp location



ORDERING INFO

SERIES	WATTAGE / LAMP	LAMP ASSEMBLY	POWER SUPPLY	VOLTAGE	FINISH	OPTIONS
MF32CR-T MULTIFORMS MF300 Series Recessed 2-Light Straight Aperture Adjustable Accent Trimmed Fixture Remodel Housing	030PR20X PAR20 30W max	TD Trim Mounted Double Gimbal	EB Electronic Metal Halide Ballast NA None - Line voltage lamps	1 120V 2 277V 3 347V*	BB Black WW White WB White Trim / Black Interior SS Silver SB Silver Trim / Black Interior XX Custom	EM Emergency
	040PR20X PAR20 40W max					
	050PR20X PAR20 50W max					
	020CR20X PAR20MH 20W					
	039CR20X PAR20MH 39W					
015PR20X LED Retrofit						
MF32CR-T						

Ordering Example: **MF32CR-T-050PR20X-TD-NA-1-BB-CP**

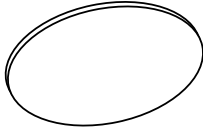
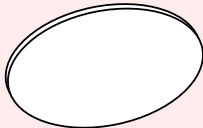
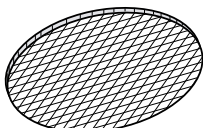
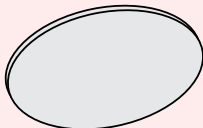
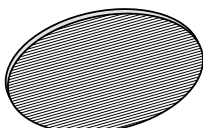
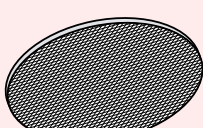
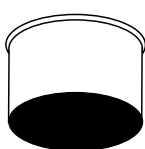
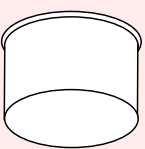
OPTICAL ACCESSORY	DESCRIPTION	LIGHT SOURCE		
		SMALL	MEDIUM	LARGE
		<ul style="list-style-type: none"> • MR16 • CMHMR16 • 50mm LED 	<ul style="list-style-type: none"> • PAR20 • PAR20CMH • T4GU6.5 • 70mm LED 	<ul style="list-style-type: none"> • PAR30 / PAR30CMH • T4G8.5 • T6G12 • AR111 / CDMR111 • 111mm LED
	Clear Lens	OPTB-CLR Ø2.00" (51mm) nom.	OPTC-CLR Ø2.90" (74mm) nom.	OPTD-CLR Ø4.40" (112mm) nom.
	Clear Lens - LED Film	OPTB-L-CLR Ø2.00" (51mm) nom.	N/A	N/A
	UV Lens	OPTB-UVL Ø2.00" (51mm) nom.	OPTC-UVL Ø2.90" (74mm) nom.	OPTD-UVL Ø4.40" (112mm) nom.
	Hex Cell Louver	OPTB-HXL Ø2.00" (51mm) nom.	OPTC-HXL Ø2.90" (74mm) nom.	OPTD-HXL Ø4.40" (112mm) nom.
	Diffusion Lens	OPTB-DFL Ø2.00" (51mm) nom.	OPTC-DFL Ø2.90" (74mm) nom.	OPTD-DFL Ø4.40" (112mm) nom.
	Diffusion Lens - LED Film	OPTB-L-DFL Ø2.00" (51mm) nom.	OPTC-L-DFL Ø2.90" (74mm) nom.	OPTD-L-DFL Ø4.40" (112mm) nom.
	Linear Spread Lens	OPTB-LSL Ø2.00" (51mm) nom.	OPTC-LSL Ø2.90" (74mm) nom.	OPTD-LSL Ø4.40" (112mm) nom.
	Linear Spread Lens - LED Film	OPTB-L-LSL Ø2.00" (51mm) nom.	OPTC-L-LSL Ø2.90" (74mm) nom.	OPTD-L-LSL Ø4.40" (112mm) nom.
	Prismatic Spread Lens	OPTB-PSL Ø2.00" (51mm) nom.	OPTC-PSL Ø2.90" (74mm) nom.	OPTD-PSL Ø4.40" (112mm) nom.
	Snoot - White With Black Splay	OPTB-SNW Ø2.00" (51mm) nom.	OPTC-SNW Ø2.90" (74mm) nom.	OPTD-SNW Ø4.40" (112mm) nom.
	Snoot - Black	OPTB-SNB Ø2.00" (51mm) nom.	OPTC-SNB Ø2.90" (74mm) nom.	OPTD-SNB Ø4.40" (112mm) nom.

* Other filters, colored glass, dichroics & micro-lenses available upon request