

PROJECT	TYPE	CATALOG NUMBER
---------	------	----------------

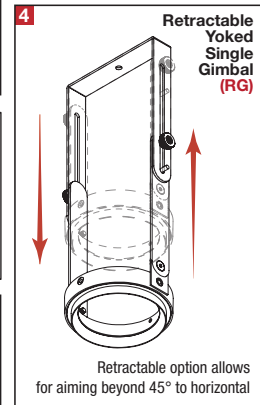
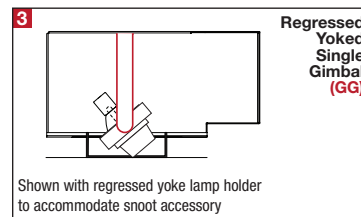
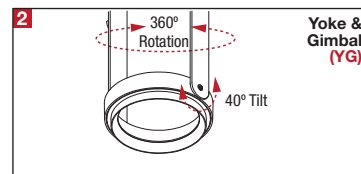
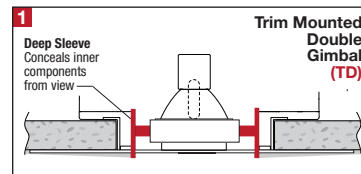
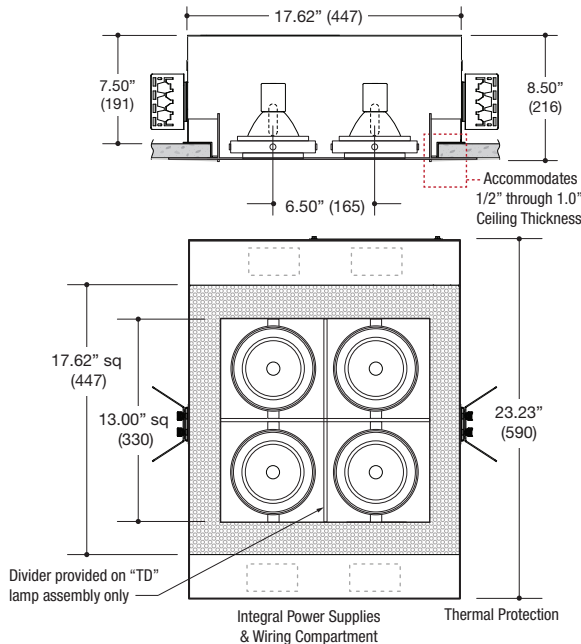

DESCRIPTION

- Four light square recessed accent / downlight - large size
- All steel 18GA construction with powder coat finish
- Trimless insert with 13.00" x 13.00" open aperture
- Perforated metal mesh frame for mudding right to the aperture
- Vent holes for cooler operating temperature
- Trimless insert features deep sleeve to conceal inner components
- Insert sleeve removable for maintenance
- **Ceiling Cut-Out - 13.12" x 13.12"**

LAMPS (not included)

- T4 / T6 G12 20W, 39W, or 70W
- Integral aluminum reflectors in narrow, medium, and wide beams
- Accepts up to 2 or more optical accessories, dependent on lamp
- Double gimbal lamp holder with up to 40° x 40° tilt aiming
- Accepts up to 2 or more optical accessories, dependent on lamp
- Trim mounted double gimbal standard with optional single gimbal flush yoke, regressed yoke or adjusting retractable yoke

ELECTRICAL

- Integral metal halide ballast
- Electrical wiring compartment integrated into housing construction
- Thermal protection
- Easy maintenance access through ceiling opening
- Rated for through-branch wiring

MOUNTING

- Butterfly brackets for commercial installation in drywall and other mud in ceiling types
- Continuously variable plate adjusts for 1/2" through 1.0" ceilings
- Heavy -Duty **L-Bars™** hanger bar system ordered separately
LF #LBARS4PK

LABELS



- Suitable for damp location



ORDERING INFO

SERIES	WATTAGE / LAMP	BEAM	LAMP ASSEMBLY	POWER SUPPLY	VOLTAGE	FINISH	OPTIONS
MF3QDN-S	020T6G1 T4/T6 G12 20W 039T6G1 T4/T6 G12 39W 070T6G1 T4/T6 G12 70W	N Narrow M Medium W Wide	TD Trim Mounted Double Gimbal YG Yoke Gimbal Flush to Ceiling Line GG Regressed Yoked Gimbal* RG Retractable Yoked Gimbal	EB Electronic Metal Halide Ballast	1 120V 2 277V	BB Black WW White SS Silver XX Custom	CP Chicago Plenum
MULTIFORMS MF300 Series Recessed 4-Light Square Straight Aperture Adjustable Accent Trimless Fixture New Construction Housing			* Required to enable flush appearance with snoot accessory				
MF3QDN-S							

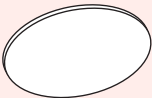
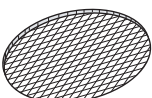
Ordering Example: **MF3QDN-S-039T6G1-N-TD-EB-1-BB-CP**

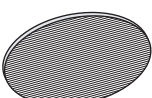
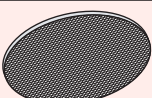
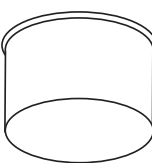
OPTICAL ACCESSORY	DESCRIPTION	LIGHT SOURCE
		LARGE
		<ul style="list-style-type: none"> • PAR30 / PAR30CMH • T4G8.5 • T6G12 • AR111 / CDMR111 • 111mm LED
	Clear Lens	OPTD-CLR
	Clear Lens - LED Film	OPTD-L-CLR
	UV Lens	OPTD-UVL
	Hex Cell Louver	OPTD-HXL
	Diffusion Lens	OPTD-DFL
	Diffusion Lens - LED Film	OPTD-L-DFL
	Linear Spread Lens	OPTBD-LSL
	Linear Spread Lens - LED Film	OPTD-L-LSL
	Prismatic Spread Lens	OPTD-PSL
	Snoot - Black	OPTD-SNB
	Snoot - White	OPTD-SNW
	Snoot - Silver	OPTD-SNS
	Snoot - White With Black Splay	OPTD-SNWB
	Snoot - Silver With Black Splay	OPTD-SNSB

* Other filters, colored glass, dichroics & micro-lenses available upon request

LED Performance Chart

BRIDGELUX

WATTAGE / LUMENS	CRI / COLOR	BEAM
22L 22W LED / 2200lm nom.	8027 80CRI / 2700K	N Narrow 17°
34L 34W LED / 2800lm nom.	8030 80CRI / 3000K	M Medium 26°
	8035 80CRI / 3500K	W Wide 52°
	8040 80CRI / 4000K	
	9027 90CRI / 2700K	
	9030 90CRI / 3000K	
	9727 97CRI / 2700K	
	9730 97CRI / 3000K	



CREE

WATTAGE / LUMENS	CRI / COLOR	BEAM
35C 35W LED / 2970lm nom.	8027 80CRI / 2700K	N Narrow 13°
41C 41W LED / 3350lm nom.	8030 80CRI / 3000K	M Medium 20°
	8035 80CRI / 3500K	W Wide 44°
	8040 80CRI / 4000K	
	9527 95CRI / 2700K	
	9530 95CRI / 3000K	
	9535 95CRI / 3500K	
	9540 95CRI / 4000K	

