

PROJECT	TYPE	CATALOG NUMBER
---------	------	----------------

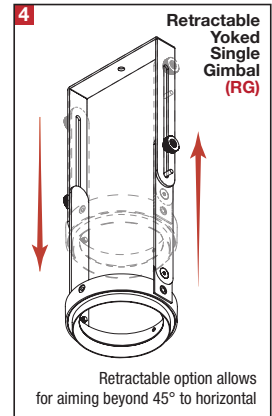
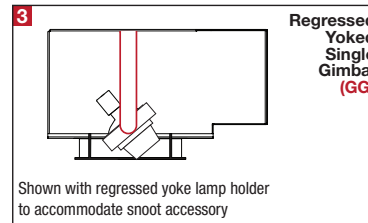
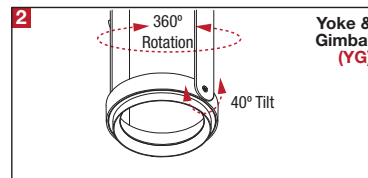
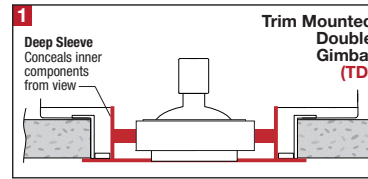
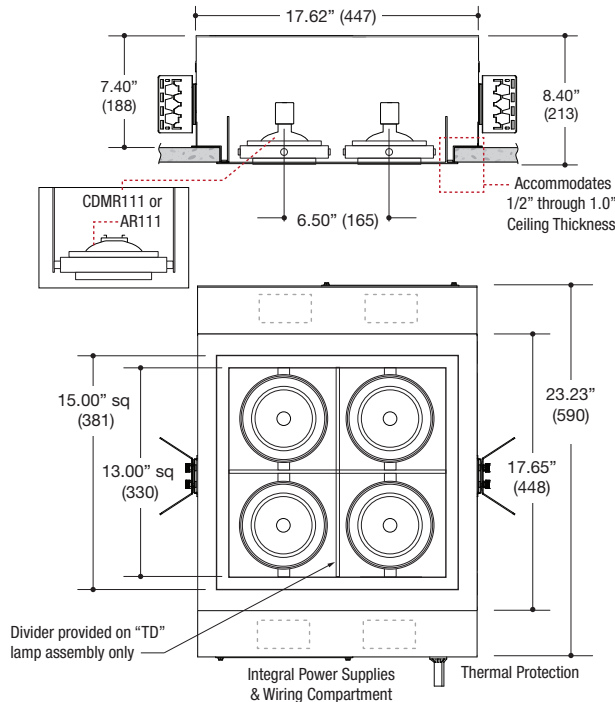

DESCRIPTION

- Four light square recessed accent / downlight - large size
- All steel 18GA construction with powder coat finish
- 1" Trim flange with 13.00" x 13.00" open aperture
- Trim flange removable for maintenance
- Vent holes for cooler operating temperature
- Trim features deep sleeve to conceal inner components
- **Ceiling Cut-Out - 13.12" x 13.12"**

LAMPS (not included)

- 12V AR111 Halogen 100W max - Derate Labels Available
- CDMR111 22W, 39W or 70W
- LED Retrofit 20W max - Works with SORAA®
- Double gimbal lamp holder with up to 40° x 40° tilt aiming (Actual angle dependent on source and installation condition)
- Accepts up to 2 or more optical accessories, dependent on lamp
- Trim mounted double gimbal standard with optional single gimbal flush yoke, regressed yoke or adjusting retractable yoke

ELECTRICAL

- Integral electronic or toroidal transformer, metal halide ballast
- Electrical wiring compartment integrated into housing construction
- Thermal protection
- Easy maintenance access through ceiling opening
- Rated for through-branch wiring
- Dimmable (12V)

MOUNTING

- Butterfly brackets for commercial installation in drywall, wood, stone, acoustic tile, or other ceiling types
- Continuously variable plate adjusts for 1/2" through 1.0" ceilings
- Heavy -Duty **L-Bars™** hanger bar system ordered separately
LF #LBARS4PK

LABELS



- Suitable for damp location



ORDERING INFO

SERIES	WATTAGE / LAMP	LAMP ASSEMBLY	POWER SUPPLY	VOLTAGE	FINISH	OPTIONS
MF3QDN-T MULTIFORMS MF300 Series Recessed 4-Light Square Straight Aperture Adjustable Accent Trimmed Fixture New Construction Housing	035AR11X AR111 35W max	TD Trim Mounted Double Gimbal	ET Electronic Transformer	1 120V	BB Black WW White WB White Trim / Black Interior SS Silver XX Custom	CP Chicago Plenum
	050AR11X AR111 50W max	YG Yoke Gimbal Flush to Ceiling Line	TT Q-Tran Toroidal Transformer	2 277V		
	100AR11X AR111 100W max	GG Regressed Yoked Gimbal*	EB Electronic Metal Halide Ballast			
	022CR11X CDMR111 22W	RG Retractable Yoked Gimbal				
	039CR11X CDMR111 39W					
070CR11X CDMR111 70W						
	020AR11X AR111 20W LED Retrofit					
MF3QDN-T						

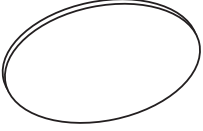
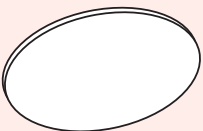
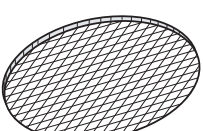
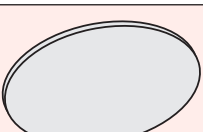
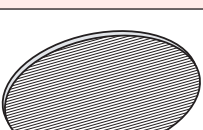
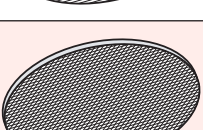
Ordering Example: **MF3QDN-T-039CR11X-TD-EB-1-BB-CP**

OPTICAL ACCESSORY	DESCRIPTION	LIGHT SOURCE		
		SMALL	MEDIUM	LARGE
		<ul style="list-style-type: none"> • MR16 • CMHMR16 • 50mm LED 	<ul style="list-style-type: none"> • PAR20 • PAR20CMH • T4GU6.5 • 70mm LED 	<ul style="list-style-type: none"> • PAR30 / PAR30CMH • T4G8.5 • T6G12 • AR111 / CDMR111 • 111mm LED
	Clear Lens	OPTB-CLR Ø2.00" (51mm) nom.	OPTC-CLR Ø2.90" (74mm) nom.	OPTD-CLR Ø4.40" (112mm) nom.
	Clear Lens - LED Film	OPTB-L-CLR Ø2.00" (51mm) nom.	N/A	N/A
	UV Lens	OPTB-UVL Ø2.00" (51mm) nom.	OPTC-UVL Ø2.90" (74mm) nom.	OPTD-UVL Ø4.40" (112mm) nom.
	Hex Cell Louver	OPTB-HXL Ø2.00" (51mm) nom.	OPTC-HXL Ø2.90" (74mm) nom.	OPTD-HXL Ø4.40" (112mm) nom.
	Diffusion Lens	OPTB-DFL Ø2.00" (51mm) nom.	OPTC-DFL Ø2.90" (74mm) nom.	OPTD-DFL Ø4.40" (112mm) nom.
	Diffusion Lens - LED Film	OPTB-L-DFL Ø2.00" (51mm) nom.	OPTC-L-DFL Ø2.90" (74mm) nom.	OPTD-L-DFL Ø4.40" (112mm) nom.
	Linear Spread Lens	OPTB-LSL Ø2.00" (51mm) nom.	OPTC-LSL Ø2.90" (74mm) nom.	OPTD-LSL Ø4.40" (112mm) nom.
	Linear Spread Lens - LED Film	OPTB-L-LSL Ø2.00" (51mm) nom.	OPTC-L-LSL Ø2.90" (74mm) nom.	OPTD-L-LSL Ø4.40" (112mm) nom.
	Prismatic Spread Lens	OPTB-PSL Ø2.00" (51mm) nom.	OPTC-PSL Ø2.90" (74mm) nom.	OPTD-PSL Ø4.40" (112mm) nom.
	Snoot - Black	OPTB-SNB Ø2.00" (51mm) nom.	OPTC-SNB Ø2.90" (74mm) nom.	OPTD-SNB Ø4.40" (112mm) nom.
	Snoot - White	OPTB-SNW Ø2.00" (51mm) nom.	OPTC-SNW Ø2.90" (74mm) nom.	OPTD-SNW Ø4.40" (112mm) nom.
	Snoot - Silver	OPTB-SNS Ø2.00" (51mm) nom.	OPTC-SNS Ø2.90" (74mm) nom.	OPTD-SNS Ø4.40" (112mm) nom.
	Snoot - White With Black Splay	OPTB-SNWB Ø2.00" (51mm) nom.	OPTC-SNWB Ø2.90" (74mm) nom.	OPTD-SNWB Ø4.40" (112mm) nom.
	Snoot - Silver With Black Splay	OPTB-SNSB Ø2.00" (51mm) nom.	OPTC-SNSB Ø2.90" (74mm) nom.	OPTD-SNSB Ø4.40" (112mm) nom.

* Other filters, colored glass, dichroics & micro-lenses available upon request