

TRIMMED

LED

MEDIUM

PROJECT	TYPE	CATALOG NUMBER
---------	------	----------------

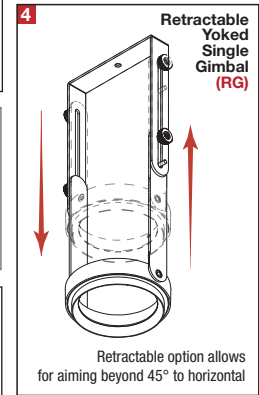
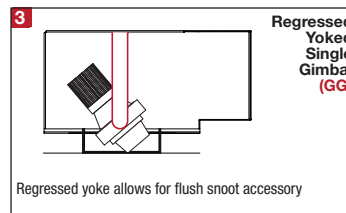
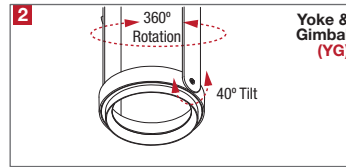
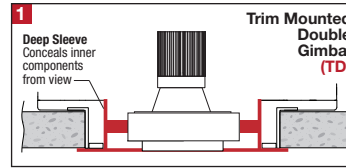
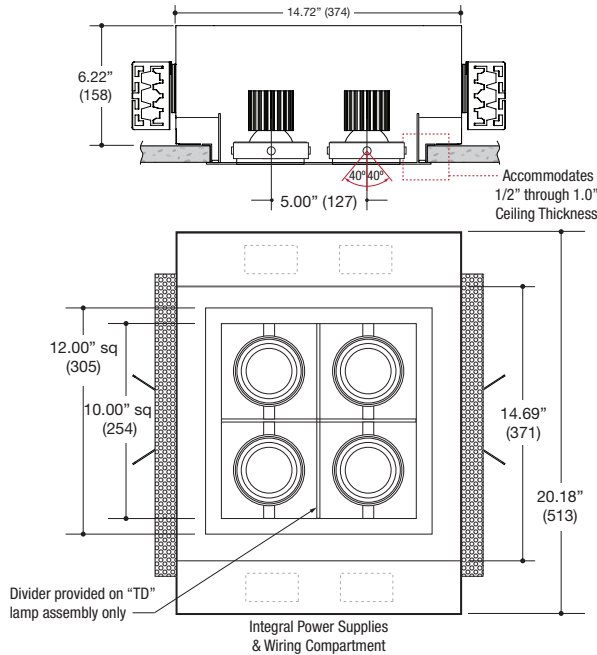

DESCRIPTION

- Four light square recessed accent / downlight - medium size
- All steel 18GA construction with powder coat finish
- 1" Trim flange with 10" x 10" open aperture
- Trim flange removable for maintenance
- Vent holes for cooler operating temperature
- Trim features deep sleeve to conceal inner components
- **Ceiling Cut-Out - 13.12" x 13.12"**

LED Source

- Field-replaceable integral LED module
- Field-changeable optic
- Bridgelux or CREE - See Performance Chart
- Accepts up to 2 or more optical accessories
- Trim mounted double gimbal standard with optional single gimbal flush yoke, regressed yoke or adjusting retractable yoke

ELECTRICAL

- Field-replaceable integral LED driver
- Electrical wiring compartment integrated into housing construction
- Thermal protection
- Easy maintenance access through ceiling opening
- Rated for through-branch wiring
- Dimmable

MOUNTING

- Butterfly brackets for commercial installation in drywall, wood, stone, acoustic tile, or other ceiling types
- Continuously variable plate adjusts for 1/2" through 1.0" ceilings
- Heavy -Duty **L-Bars™** hanger bar system ordered separately

LF #LBARS4PK

LABELS

- Suitable for damp location



5 YEAR WARRANTY
Limited



ORDERING INFO

SERIES	BRIDGELUX	CRI / COLOR	CREE	CRI / COLOR	BEAM	LAMP ASSEMBLY	DRIVER	VOLTAGE	FINISH	OPTIONS				
MF3QCN-T MULTIFORMS MF300 Series Recessed 4-Light Straight Aperture Adjustable Accent Trimmed Fixture New Construction Housing	17L	8027	20C	8027	N	TD	D1 Phase Dimming (120V only) D2 0-10V Dimming (120-277V only) D3 Lutron Hi-lume™* Forward Phase 2 wire 1% (120V only) D4 Lutron Hi-lume™* EcoSystem™ & 3 wire 1% (120-277V only) DE Lutron Hi-lume™ EcoSystem™* 1% w/Soft-On, Fade-to-Black™ 1% (120-277V only) *Consult factory for further dimming options	1 120V U 120-277V	BB Black WW White WB White Trim / Black Interior SS Silver SB Silver Trim / Black Interior XX Custom	CP Chicago Plenum EM Remotely mounted emergency LED inverter				
	22L	8030	28C	8030	Narrow	Trim Mounted								
		8035		8035	M	Double Gimbal								
		8040		8040	Medium	YG								
		9027		9527	W	Yoke Gimbal Flush to Ceiling Line								
		9030		9530	Wide	GG								
		9727		9535		Regressed Yoked Gimbal*								
		9730		9540		RG								
	REFERENCE PERFORMANCE CHART										Retractable Yoked Gimbal			
											* Required to enable flush appearance with snoot accessory.			
MF3QCN-T														

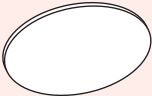
Ordering Example: **MF3QCN-T-22L-8027-N-TD-D2-U-BB-CP**

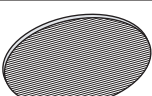
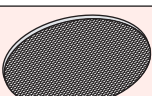
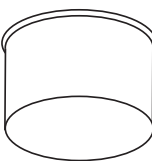
OPTICAL ACCESSORY	DESCRIPTION	LIGHT SOURCE
		MEDIUM
		<ul style="list-style-type: none"> • PAR20 • PAR20CMH • T4GU6.5 • 70mm LED
	Clear Lens	OPTC-CLR
	UV Lens	OPTC-UVL
	Hex Cell Louver	OPTC-HXL
	Diffusion Lens	OPTC-DFL
	Diffusion Lens - LED Film	OPTC-L-DFL
	Linear Spread Lens	OPTBC-LSL
	Linear Spread Lens - LED Film	OPTC-L-LSL
	Prismatic Spread Lens	OPTC-PSL
	Snoot - Black	OPTC-SNB
	Snoot - White	OPTC-SNW
	Snoot - Silver	OPTC-SNS
	Snoot - White With Black Splay	OPTC-SNWB
	Snoot - Silver With Black Splay	OPTC-SNSB

* Other filters, colored glass, dichroics & micro-lenses available upon request

LED Performance Chart

BRIDGELUX

WATTAGE / LUMENS	CRI / COLOR	BEAM
17L 17W LED / 1700lm nom.	8027 80CRI / 2700K	N
22L 22W LED / 2200lm nom.	8030 80CRI / 3000K	Narrow 22°
	8035 80CRI / 3500K	M
	8040 80CRI / 4000K	Medium 43°
	9027 90CRI / 2700K	W
	9030 90CRI / 3000K	Wide 58°
	9727 97CRI / 2700K	
	9730 97CRI / 3000K	



CREE

WATTAGE / LUMENS	CRI / COLOR	BEAM
20C 20W LED / 1800lm nom.	8027 80CRI / 2700K	N
28C 28W LED / 2200lm nom.	8030 80CRI / 3000K	Narrow 14°
	8035 80CRI / 3500K	M
	8040 80CRI / 4000K	Medium 30°
	9527 95CRI / 2700K	W
	9530 95CRI / 3000K	Wide 40°
	9535 95CRI / 3500K	
	9540 95CRI / 4000K	

