

PROJECT	TYPE	CATALOG NUMBER
---------	------	----------------

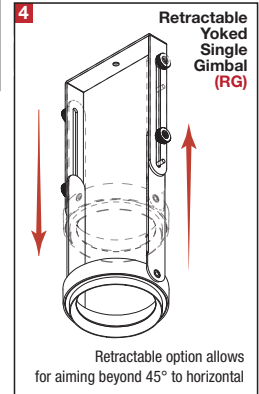
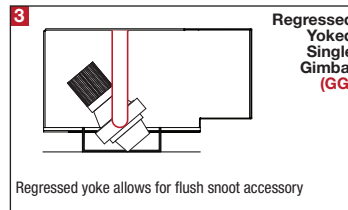
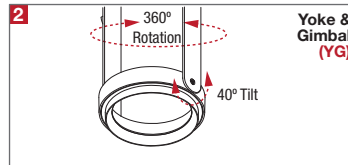
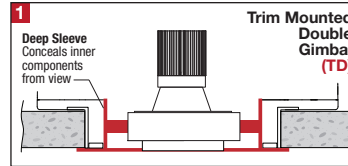
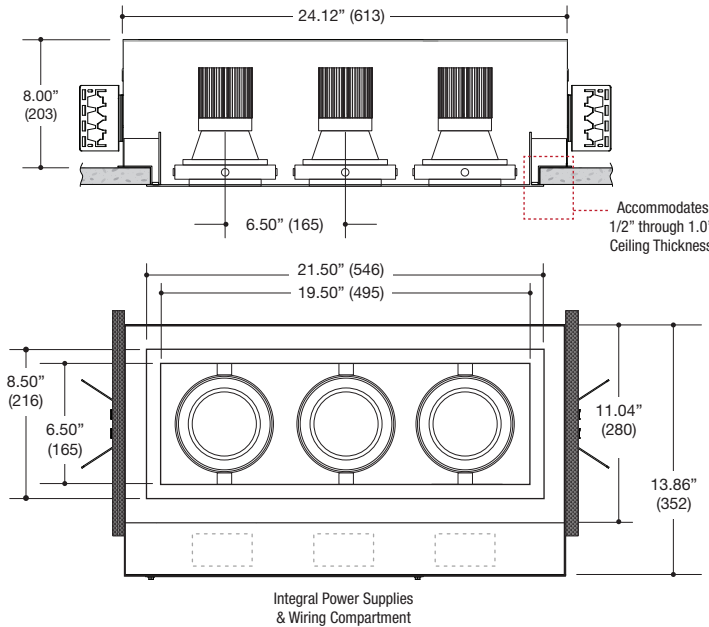

DESCRIPTION

- Three light recessed accent / downlight - large size
- All steel 18GA construction with powder coat finish
- 1" Trim flange with 6.50" x 19.50" open aperture
- Trim flange removable for maintenance
- Vent holes for cooler operating temperature
- Trim features deep sleeve to conceal inner components
- **Ceiling Cut-Out - 7.12" x 20.50"**

LED Source

- Field-replaceable integral LED module
- Field-changeable optic
- Bridgelux or CREE - See Performance Chart
- Accepts up to 2 or more optical accessories
- Trim mounted double gimbal standard with optional single gimbal flush yoke, regressed yoke or adjusting retractable yoke

ELECTRICAL

- Integral LED driver
- Electrical wiring compartment integrated into housing construction
- Thermal protection
- Easy maintenance access through ceiling opening
- Rated for through-branch wiring
- Dimmable

MOUNTING

- Butterfly brackets for commercial installation in drywall, wood, stone, acoustic tile, or other ceiling types
- Continuously variable plate adjusts for 1/2" through 1.0" ceilings
- Heavy -Duty **L-Bars™** hanger bar system ordered separately **LF #LBARS4PK**

LABELS

- Suitable for damp location



5 YEAR WARRANTY
Limited



ORDERING INFO

SERIES	BRIDGELUX	CRI / COLOR	CREE	CRI / COLOR	BEAM	LAMP ASSEMBLY	DRIVER	VOLTAGE	FINISH	OPTIONS			
MF33DN-T MULTIFORMS MF300 Series Recessed 3-Light Straight Aperture Adjustable Accent Trimmed Fixture New Construction Housing	22L	8027	35C	8027	N	TD	D1 Phase Dimming (120V only)	1 120V U 120-277V	BB Black WW White WB White Trim / Black Interior SS Silver SB Silver Trim / Black Interior XX Custom	CP Chicago Plenum EM Remotely mounted emergency LED inverter			
	34L	8030	41C	8030	Narrow	TD	D2 0-10V Dimming (120-277V only)						
		8035		M	YG	D3 Lutron Hi-lume™* Forward Phase 2 wire 1% (120V only)							
		8040		Medium	GG	D4 Lutron Hi-lume™* EcoSystem™ & 3 wire 1% (120-277V only)							
		9027		W	DE	Lutron Hi-lume™ EcoSystem™* 1% w/Soft-On, Fade-to-Black™ 1% (120-277V only)							
		9030		Wide	RG	*Consult factory for further dimming options							
		9727											
		9730											
		REFERENCE PERFORMANCE CHART											
	MF33DN-T												

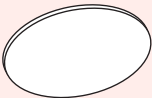
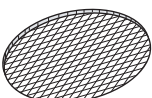
Ordering Example: **MF33DN-T-22L-8027-N-TD-D1-1-BB-CP**

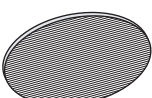
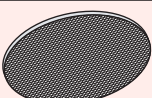
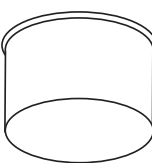
OPTICAL ACCESSORY	DESCRIPTION	LIGHT SOURCE
		LARGE
		<ul style="list-style-type: none"> • PAR30 / PAR30CMH • T4G8.5 • T6G12 • AR111 / CDMR111 • 111mm LED
	Clear Lens	OPTD-CLR
	Clear Lens - LED Film	OPTD-L-CLR
	UV Lens	OPTD-UVL
	Hex Cell Louver	OPTD-HXL
	Diffusion Lens	OPTD-DFL
	Diffusion Lens - LED Film	OPTD-L-DFL
	Linear Spread Lens	OPTBD-LSL
	Linear Spread Lens - LED Film	OPTD-L-LSL
	Prismatic Spread Lens	OPTD-PSL
	Snoot - Black	OPTD-SNB
	Snoot - White	OPTD-SNW
	Snoot - Silver	OPTD-SNS
	Snoot - White With Black Splay	OPTD-SNWB
	Snoot - Silver With Black Splay	OPTD-SNSB

* Other filters, colored glass, dichroics & micro-lenses available upon request

LED Performance Chart

BRIDGELUX

WATTAGE / LUMENS	CRI / COLOR	BEAM
22L 22W LED / 2200lm nom.	8027 80CRI / 2700K	N Narrow 17°
34L 34W LED / 2800lm nom.	8030 80CRI / 3000K	M Medium 26°
	8035 80CRI / 3500K	W Wide 52°
	8040 80CRI / 4000K	
	9027 90CRI / 2700K	
	9030 90CRI / 3000K	
	9727 97CRI / 2700K	
	9730 97CRI / 3000K	



CREE

WATTAGE / LUMENS	CRI / COLOR	BEAM
35C 35W LED / 2970lm nom.	8027 80CRI / 2700K	N Narrow 13°
41C 41W LED / 3350lm nom.	8030 80CRI / 3000K	M Medium 20°
	8035 80CRI / 3500K	W Wide 44°
	8040 80CRI / 4000K	
	9527 95CRI / 2700K	
	9530 95CRI / 3000K	
	9535 95CRI / 3500K	
	9540 95CRI / 4000K	

