

PROJECT	TYPE	CATALOG NUMBER
---------	------	----------------

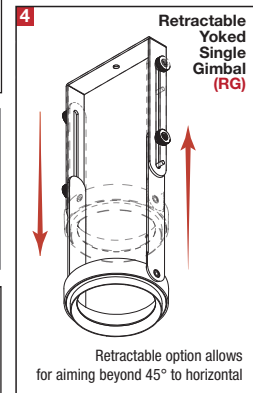
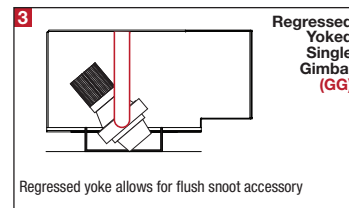
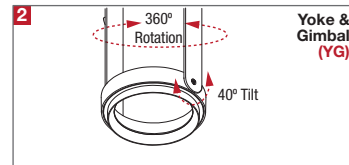
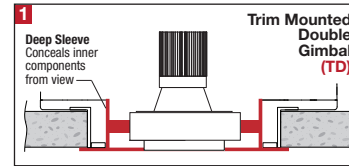
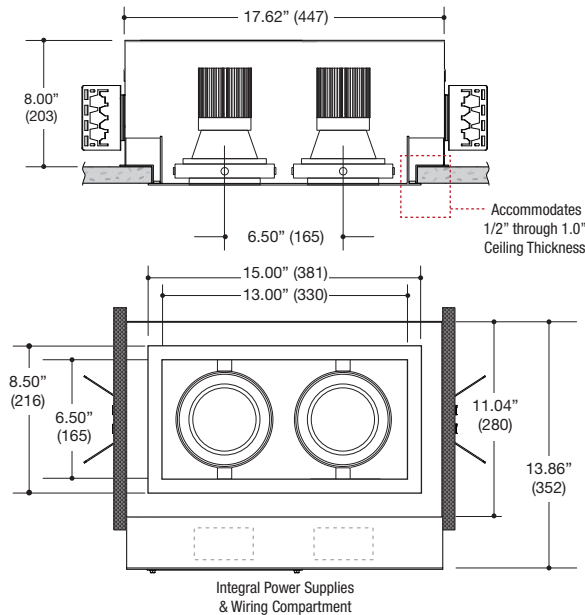

#### DESCRIPTION

- Two light recessed accent / downlight - large size
- All steel 18GA construction with powder coat finish
- 1" Trim flange with 6.50" x 13.00" open aperture
- Trim flange removable for maintenance
- Vent holes for cooler operating temperature
- Trim features deep sleeve to conceal inner components
- **Ceiling Cut-Out - 7.12" x 13.94"**

#### LED Source

- Field-replaceable integral LED module
- Field-changeable optic
- Bridgelux or CREE - See Performance Chart
- Accepts up to 2 or more optical accessories
- Trim mounted double gimbal standard with optional single gimbal flush yoke, regressed yoke or adjusting retractable yoke

#### ELECTRICAL

- Integral LED driver
- Electrical wiring compartment integrated into housing construction
- Thermal protection
- Easy maintenance access through ceiling opening
- Rated for through-branch wiring
- Dimmable

#### MOUNTING

- Butterfly brackets for commercial installation in drywall, wood, stone, acoustic tile, or other ceiling types
- Continuously variable plate adjusts for 1/2" through 1.0" ceilings
- Heavy -Duty **L-Bars™** hanger bar system ordered separately **LF #LBARS4PK**

#### LABELS



- Suitable for damp location



#### ORDERING INFO

SERIES	BRIDGELUX	CRI / COLOR	CREE	CRI / COLOR	BEAM	LAMP ASSEMBLY	DRIVER	VOLTAGE	FINISH	OPTIONS					
<b>MF32DN-T</b>  <b>MULTIFORMS MF300 Series</b> Recessed 2-Light Straight Aperture Adjustable Accent Trimmed Fixture New Construction Housing	22L	8027	35C	8027	N	TD	<b>D1</b> Phase Dimming (120V only) <b>D2</b> 0-10V Dimming (120-277V only) <b>D3</b> Lutron Hi-lume™* Forward Phase 2 wire 1% (120V only) <b>D4</b> Lutron Hi-lume™* EcoSystem™ & 3 wire 1% (120-277V only) <b>DE</b> Lutron Hi-lume™ EcoSystem™* 1% w/Soft-On, Fade-to-Black™ 1% (120-277V only)  *Consult factory for further dimming options	<b>1</b> 120V <b>U</b> 120-277V	<b>BB</b> Black <b>WW</b> White <b>WB</b> White Trim / Black Interior <b>SS</b> Silver <b>SB</b> Silver Trim / Black Interior <b>XX</b> Custom	<b>CP</b> Chicago Plenum  <b>EM</b> Remotely mounted emergency LED inverter					
	34L	8030	41C	8030	Narrow	Trim Mounted Double Gimbal									
		8035		8035	M	Yoke Gimbal Flush to Ceiling Line									
		8040		8040	Medium	Yoked Gimbal									
		9027		9527	W	Regressed Yoked Gimbal*									
		9030		9530	Wide	Retractable Yoked Gimbal									
		9727		9535		* Required to enable flush appearance with snoot accessory.									
		9730		9540											
	<b>REFERENCE PERFORMANCE CHART</b>														
	<b>MF32DN-T</b>														

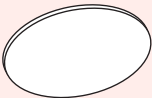
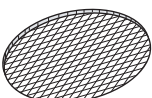
Ordering Example: **MF32DN-T-22L-8027-N-TD-D1-1-BB-CP**

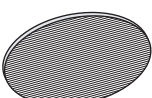
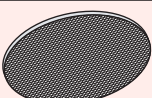
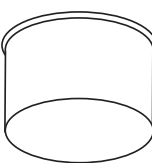
OPTICAL ACCESSORY	DESCRIPTION	LIGHT SOURCE
		LARGE
		<ul style="list-style-type: none"> <li>• PAR30 / PAR30CMH</li> <li>• T4G8.5</li> <li>• T6G12</li> <li>• AR111 / CDMR111</li> <li>• 111mm LED</li> </ul>
	Clear Lens	OPTD-CLR
	Clear Lens - LED Film	OPTD-L-CLR
	UV Lens	OPTD-UVL
	Hex Cell Louver	OPTD-HXL
	Diffusion Lens	OPTD-DFL
	Diffusion Lens - LED Film	OPTD-L-DFL
	Linear Spread Lens	OPTBD-LSL
	Linear Spread Lens - LED Film	OPTD-L-LSL
	Prismatic Spread Lens	OPTD-PSL
	Snoot - Black	OPTD-SNB
	Snoot - White	OPTD-SNW
	Snoot - Silver	OPTD-SNS
	Snoot - White With Black Splay	OPTD-SNWB
	Snoot - Silver With Black Splay	OPTD-SNSB

\* Other filters, colored glass, dichroics & micro-lenses available upon request

## LED Performance Chart

### BRIDGELUX

WATTAGE / LUMENS	CRI / COLOR	BEAM
<b>22L</b> 22W LED / 2200lm nom.	<b>8027</b> 80CRI / 2700K	<b>N</b> Narrow 17°
<b>34L</b> 34W LED / 2800lm nom.	<b>8030</b> 80CRI / 3000K	<b>M</b> Medium 26°
	<b>8035</b> 80CRI / 3500K	<b>W</b> Wide 52°
	<b>8040</b> 80CRI / 4000K	
	<b>9027</b> 90CRI / 2700K	
	<b>9030</b> 90CRI / 3000K	
	<b>9727</b> 97CRI / 2700K	
	<b>9730</b> 97CRI / 3000K	



### CREE

WATTAGE / LUMENS	CRI / COLOR	BEAM
<b>35C</b> 35W LED / 2970lm nom.	<b>8027</b> 80CRI / 2700K	<b>N</b> Narrow 13°
<b>41C</b> 41W LED / 3350lm nom.	<b>8030</b> 80CRI / 3000K	<b>M</b> Medium 20°
	<b>8035</b> 80CRI / 3500K	<b>W</b> Wide 44°
	<b>8040</b> 80CRI / 4000K	
	<b>9527</b> 95CRI / 2700K	
	<b>9530</b> 95CRI / 3000K	
	<b>9535</b> 95CRI / 3500K	
	<b>9540</b> 95CRI / 4000K	

