

TRIMLESS

LED

SMALL

PROJECT	TYPE	CATALOG NUMBER
---------	------	----------------

Measurements in () are metric equivalents.
* IC housing dimension

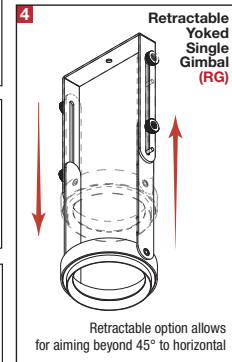
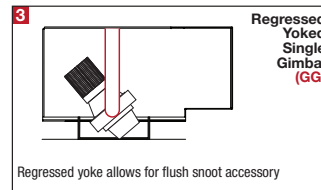
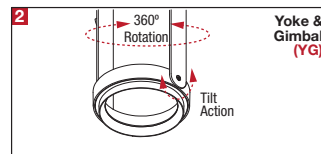
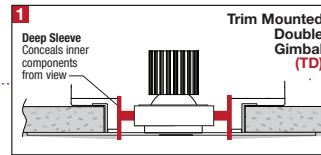
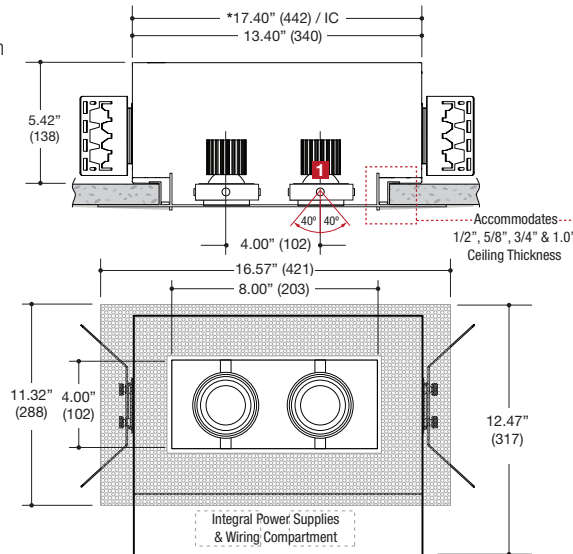

DESCRIPTION

- Two light recessed accent / downlight - Small size
- All steel 18GA construction with powder coat finish
- Trimless insert with 4" x 8" open aperture
- Perforated metal mesh frame for mudding right to the aperture
- Vent holes for cooler operating temperature
- Trimless insert features deep sleeve to conceal inner components
- Insert sleeve removable for maintenance
- **Ceiling Cut-Out - 4.50" x 9.12"**

LED Source

- Field-replaceable integral LED module
- Field-changeable optic
- Bridgelux / CREE / ValuDIM™
- Accepts up to 2 or more optical accessories
- Trim mounted double gimbal standard with optional single gimbal flush yoke, regressed yoke or adjusting retractable yoke

ELECTRICAL

- Field-replaceable integral LED driver
- Electrical wiring compartment integrated into housing construction
- Thermal protection
- Easy maintenance access through ceiling opening
- Rated for through-branch wiring
- Dimmable

MOUNTING

- Butterfly brackets for commercial installation in drywall and other mud in ceiling types
- Perforated plate adjusts for 1/2", 5/8", 3/4" & 1.0" ceiling thickness
- Heavy-Duty **L-Bars™** hanger bar system ordered separately
LF #LBARS4PK

LABELS

- Suitable for damp location



5 YEAR WARRANTY
Limited



ORDERING INFO

SERIES	LED MODULE WATTAGE AND INFORMATION	CRI / COLOR	BEAM	HSG TYPE	DRIVER	VOLTAGE	FINISH	OPTIONS
MF32BN-S MULTIFORMS MF300 Series Recessed 2-Light Straight Aperture Adjustable Accent Trimless Fixture New Construction Housing	BRIDGELUX 11L 11W LED / 825lm nom. 16L 16W LED / 1100lm nom.	8027 80CRI / 2700K Bridgelux / CREE 8030 80CRI / 3000K Bridgelux / CREE 8035 80CRI / 3500K Bridgelux / CREE 8040 80CRI / 4000K Bridgelux / CREE 9027 90CRI / 2700K Bridgelux Only 9030 90CRI / 3000K Bridgelux Only 9727 97CRI / 2700K Bridgelux Only 9730 97CRI / 3000K Bridgelux Only 9527 95CRI / 2700K CREE Only 9530 95CRI / 3000K CREE Only 9535 95CRI / 3500K CREE Only 9540 95CRI / 4000K CREE Only	BRIDGELUX N Narrow 20° M Medium 28° W Wide 40° V Very Wide 74°	TD Trim Mounted Double Gimbal YG Yoke Gimbal Flush to Ceiling Line GG Regressed Yoked Gimbal* RG Retractable Yoked Gimbal	D1 Phase Dimming (120V only) D2 0-10V Dimming (120-277V only) D3 Lutron Hi-lume™ Forward Phase (120V only) D4 Lutron Hi-lume™ EcoSystem™ & 3 wire 1% (120-277V only) DE Lutron Hi-lume™ EcoSystem™ 1% with Soft-On, Fade-to-Black™ 1% (120-277V only)	1 120V U 120-277V	BB Black WW White SS Silver XX Custom	IC* Insulated Ceiling EM Remotely Mounted Emergency LED Inverter * See drawing for extended length dimension
	CREE 09C 09W LED / 900lm nom. 14C 14W LED / 1200lm nom. 20C 20W LED / 1600lm nom.	9220 92CRI / 3000-2000K Warm Dimming ValuDIM Only	ValuDIM™ N Narrow 17° M Medium 25° W Wide 38°	* Required to enable flush appearance with snoot accessory.				
	ValuDIM™ 15V 15W LED / 810lm nom. 3000-2000K Warm Dimming							
	MF32BN-S							

Example: **MF32BN-S-14C-8027-N-TD-D2-U-BB-IC**

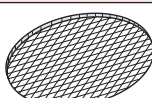
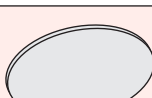
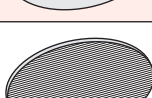
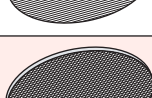
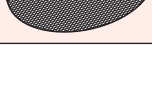
OPTICAL ACCESSORY	DESCRIPTION	LIGHT SOURCE
		SMALL
		<ul style="list-style-type: none"> • MR16 • CMHMR16 • 50mm LED
	Clear Lens	OPTB-CLR
	Clear Lens - LED Film	OPTB-L-CLR
	UV Lens	OPTB-UVL
	Hex Cell Louver	OPTB-HXL
	Diffusion Lens	OPTB-DFL
	Diffusion Lens - LED Film	OPTB-L-DFL
	Linear Spread Lens	OPTB-LSL
	Linear Spread Lens - LED Film	OPTB-L-LSL
	Prismatic Spread Lens	OPTB-PSL
	Snoot - Black	OPTB-SNB
	Snoot - White	OPTB-SNW
	Snoot - Silver	OPTB-SNS
	Snoot - White With Black Splay	OPTB-SNWB
	Snoot - Silver With Black Splay	OPTB-SNSB

* Other filters, colored glass, dichroics & micro-lenses available upon request



ValuDIM™

LF Illumination's new **ValuDIM™** warm dimming allows the features of warm dimming technology to be installed in fixtures and price points once thought impossible. The small footprint LED COB design uses many of our standard subassembly components and is compatible with virtually all standard dimming protocols currently available.

The LED itself maintains 95CRI typ (92CRI min) across the usable CCT range of 3000K to 2000K and dims down to around 2% visible light output. ValuDIM™ comes in three standard beam spread offerings of 17° narrow, 25° medium and 38° wide.



5 YEAR WARRANTY
Limited