

PROJECT	TYPE	CATALOG NUMBER
---------	------	----------------

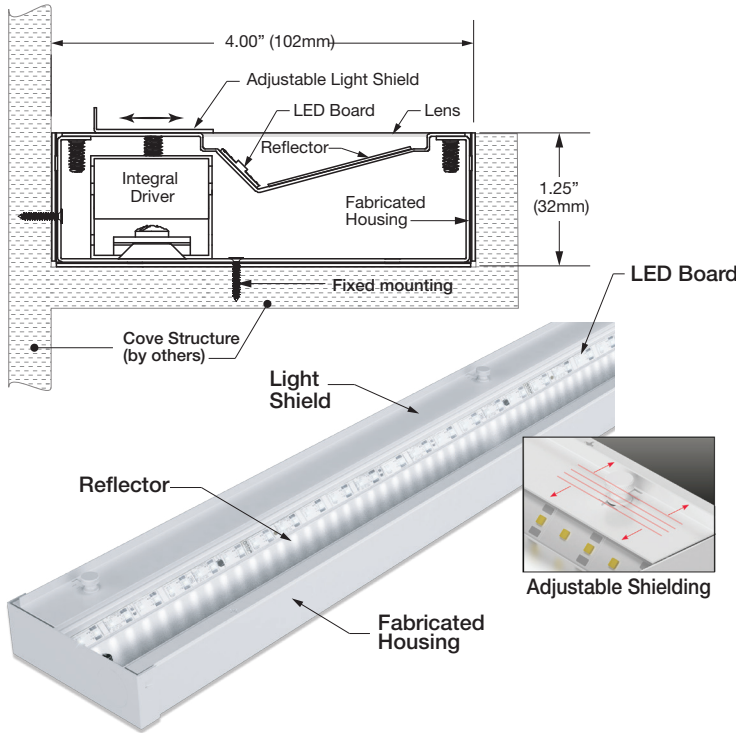

ADJUSTABLE LIGHT SHIELDING

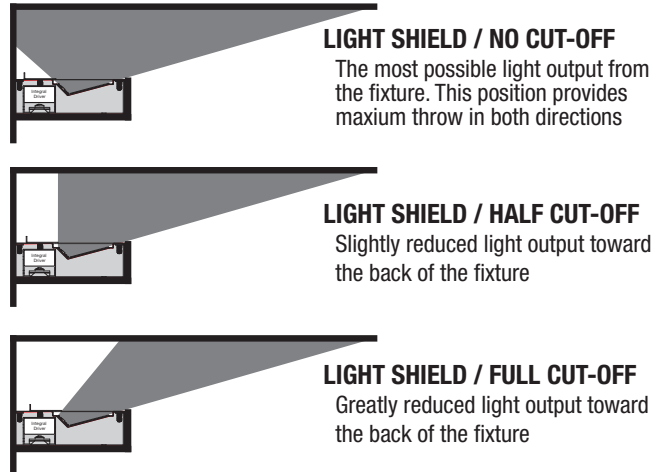

LIGHT SHIELD / NO CUT-OFF
The most possible light output from the fixture. This position provides maximum throw in both directions

LIGHT SHIELD / HALF CUT-OFF
Slightly reduced light output toward the back of the fixture

LIGHT SHIELD / FULL CUT-OFF
Greatly reduced light output toward the back of the fixture

EF600 Features

- 3 Power levels up to 1200 lumens
- Uninterrupted illumination
- End-to-end continuous run

CONSTRUCTION

- 4.00" (102) wide x 1.25" (32) tall fabricated metal housing
- Powder coat finish

LED Source

- Available at three power levels up to 1200 lumens per foot
- Tight binning ensures color consistency within 2 MacAdam ellipses
- Dense pitch for uniform output

OPTICS

- Asymmetric distribution / protective clear lens
- Optional soft cutoff lens
- Integral semi-specular reflector
- Backlight shield allows user to adjust the distribution to suit the field condition

ELECTRICAL

- Field-replaceable integral LED driver
- Integral wiring compartment in housing
- Integral thermal protection
- Easy maintenance access via lens assembly
- Quick disconnect through wiring for continuous runs

MOUNTING

- Surface mount
- End-to end for continuous uninterrupted illumination
- For joiner options to connect multiple EF600 sections see page 2.

LABELS

- Suitable for damp location



ORDERING INFO

SERIES	WATTAGE / FT	CRI / COLOR	LENS	DRIVER	LENGTH	VOLTAGE	FINISH
EF6-C EF600 Medium LED Surface mount	04L 04W LED 440 lm / ft nom. 08L 08W LED 800 lm / ft nom. 10L 12W LED 1200 lm / ft nom.	8027 80CRI / 2700K	PL Protective Clear Lens SL Softening Lens	D2 0-10V Dim. Driver (120-277V only) D3 Lutron Hi-lume™ Forward Phase (120V only) D4 Lutron Hi-lume™ 3 wire (1%) (120-277V only) E4 Dimmable Lutron Hi-lume™ 1% EcoSystem™ LED driver (120-277V only) D8 Dimmable DALI 1% LED driver (120-277V only)	018 18" 1.5ft 024 24" 2ft 036 36" 3ft 048 48" 4ft 060 60" 5ft 072 72" 6ft 096 96" 8ft	1 120V U 120-277V	WW White
		8030 80CRI / 3000K					
		8035 80CRI / 3500K					
		8040 80CRI / 4000K					
		9027 90CRI / 2700K 9030 90CRI / 3000K 9035 90CRI / 3500K					
		<i>Consult factory for other CRI / Color options</i>					
EF6-C							

Ordering Example: **EF6-C-04L-8027-PL-D2-048-1-WW**

PROJECT

TYPE

CATALOG NUMBER

ELBOW JOINER KIT

- Elbow joiner for curved / angled applications
- 0-90° joint motion
- Top or bottom pin locations for reverse action

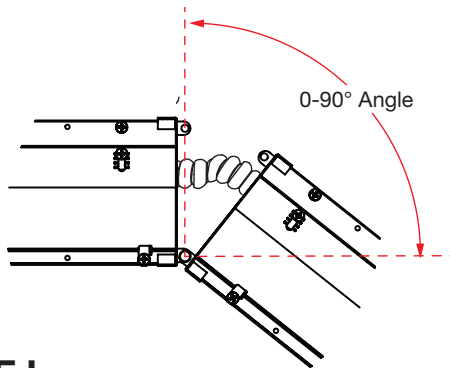

EF6-C-EJ

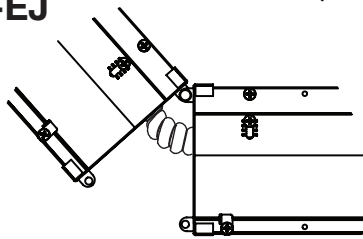

Kit Includes

- 2 End Caps
- 1 Hinge Pin
- 1 Cotter Key
- Armored Conduit Electrical Whip

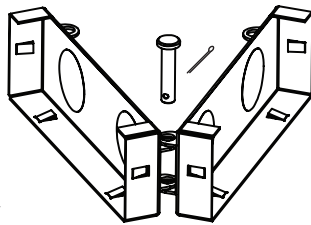

ORDERING INFO

SERIES	FINISH
EF6-C-EJ	WW White
ELBOW JOINER KIT White Finish	
EF6-C	

Ordering Example: **EF6-C-EJ-WW**

STRAIGHT JOINER KIT

- Smooth continuous run applications
- Easy snap-in joiner
- Quick-disconnects power supply

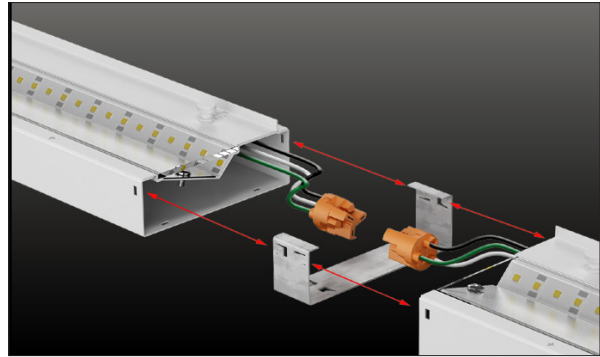

EF6-C-JN

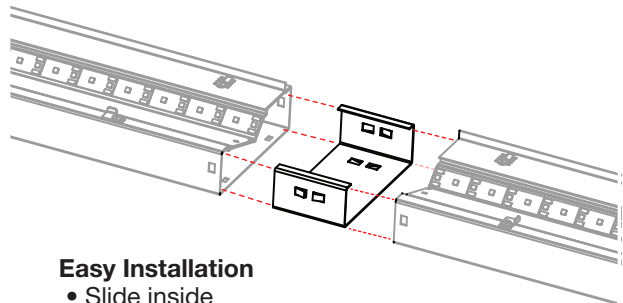

Easy Installation

- Slide inside
- Locks in place

ORDERING INFO

SERIES	FINISH
EF6-C-JN	WW White
STRAIGHT JOINER KIT White Finish	
EF6-C-JN	

Ordering Example: **EF6-C-JN-WW**