

PROJECT	TYPE	CATALOG NUMBER
---------	------	----------------

Specifications

SPOTLIGHT

- 3.15" diameter cylinder
- 125° x 125° arm articulation - Friction lock
- 90° x 90° head rotation - Friction lock
- Die cast aluminum optical housing
- Articulating arm allows for greater aiming
- Powder coat finish

LED SOURCE

CREE

- Field-replaceable integral LED module
- Field-changeable optic
- Easy access via front ring snap-in catch action.
- 08W / 962lm (@ 80CRI min / 3000K) Delivered
- 13W / 1294lm (@ 80CRI min / 3000K) Delivered
- 19W / 1860lm (@ 80CRI min / 3000K) Delivered
- 26W / 2500lm (@ 80CRI min / 3000K) Delivered

ValuDIM™

- 15W LED / 810lm 3000-2000K Warm Dimming
- Accepts 1 or more optical accessories

ELECTRICAL

- Field-replaceable LED driver
- Dimmable

MOUNTING

- Fabricated aluminum extension arm
- Side channel magnetic mount
- Designed for EF400 - EF4BNS Channel

LABELS

- Suitable for damp location

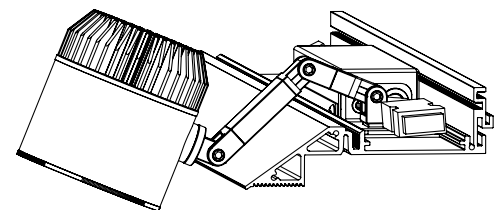
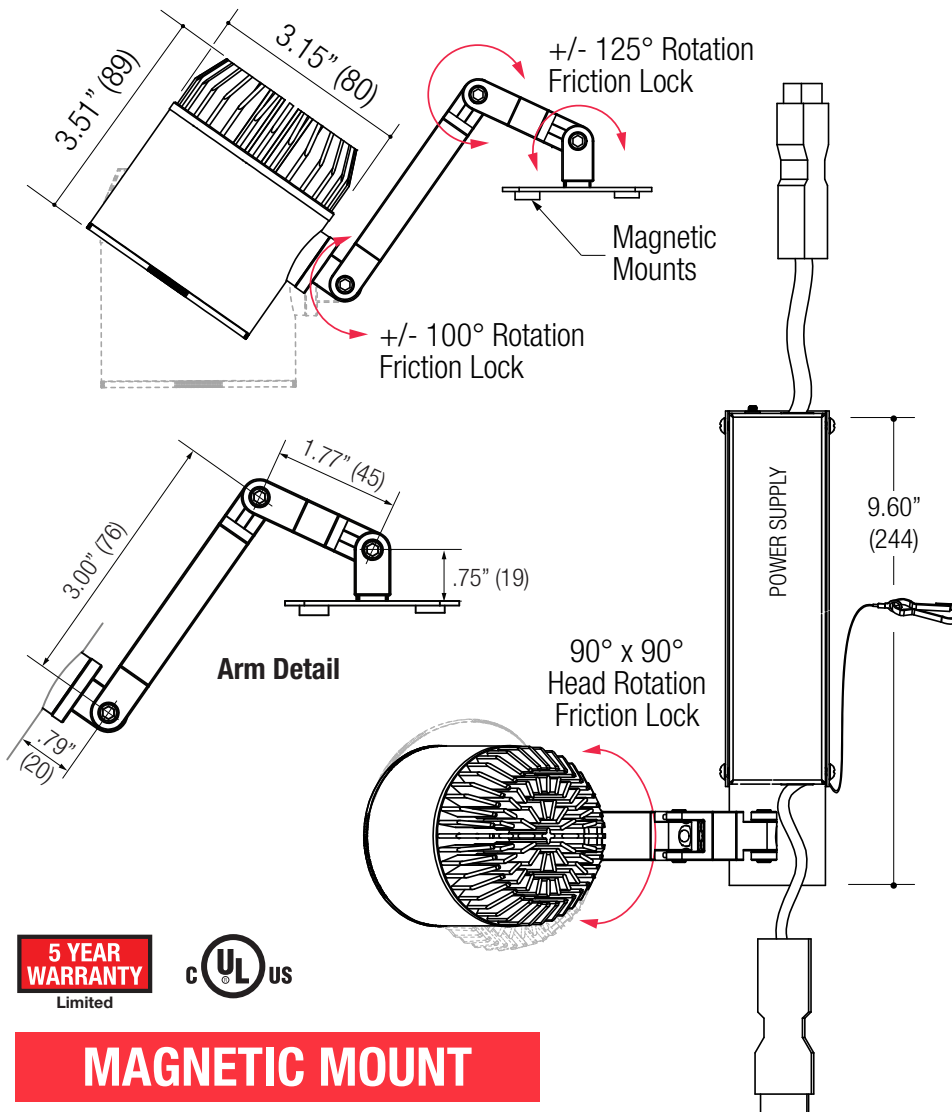

Application View

EF400 / EFBNS Channel Shown

5 YEAR WARRANTY
Limited



MAGNETIC MOUNT

ORDERING INFO

SERIES	WATTAGE	CRI / COLOR	BEAM	DRIVER / VOLTAGE	FINISH
EF408B	08C 08W LED 962 lm del.	8027 80CRI / 2700K 8030 80CRI / 3000K	N Narrow 13° M Medium 22°	DMU Dimming Multiple Forward/Reverse Phase (@ 120V only) 0-10V Wires Present (@ 120-277V)	BB Black WW White Consult factory for custom colors. Minimum order required. Bezels only available in black or white.
EF400 Cylindrical Small Die Cast Aluminum Housing Variable Adjustment EF400 Channel Mount	13C 13W LED 1294 lm del. 19C 19W LED 1860 lm del. 26C 26W LED 2500 lm del.	8035 80CRI / 3500K 8040 80CRI / 4000K 9227 95CRI / 2700K 9230 95CRI / 3000K 9235 95CRI / 3500K 9240 95CRI / 4000K	W Wide 30° V Very Wide 50°		
	ValuDIM™ 15V 15W LED / 810lm nom. 3000-2000K Warm Dimming	9220 92CRI / 3000-2000K Warm Dimming (ValuDIM Only)			

Ordering Example: **EF408B-13C-8027-W-DMU-BB**

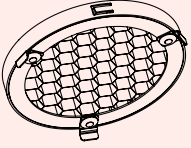
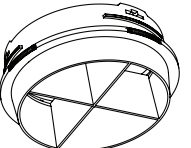
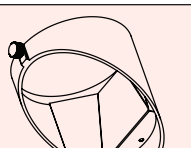
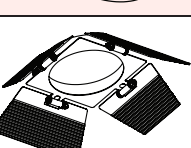
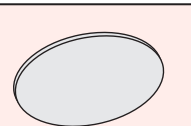
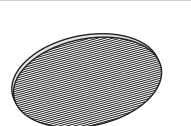
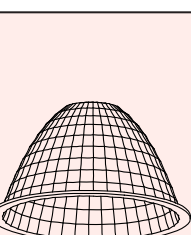
OPTICAL ACCESSORY	DESCRIPTION	LED SOURCE			
		EF208B / EF408B	EF208C / EF408C	EF208D / EF408D	
		<ul style="list-style-type: none"> • 09W LED • 14W LED • 21W LED • 28W LED 	<ul style="list-style-type: none"> • 28W LED • 35W LED • 41W LED 	<ul style="list-style-type: none"> • 34W LED • 40W LED • 55W LED 	
	Hex Cell Louver - Black	OPT-EF208B-HXL	OPT-EF208C-HXL	OPT-EF208D-HXL	
	Snoot with Cross Baffle White	OPT-EF208B-CBWW	OPT-EF208C-CBWW	OPT-EF208D-CBWW	
	Snoot with Cross Baffle Black	OPT-EF208B-CBBB	OPT-EF208C-CBBB	OPT-EF208D-CBBB	
	Wallwash - White	OPT-EF208B-WWWW	OPT-EF208C-WWWW	OPT-EF208D-WWWW	
	Wallwash - Black	OPT-EF208B-WWBB	OPT-EF208C-WWBB	OPT-EF208D-WWBB	
	Barn Doors - White	OPT-EF208B-BDWW	OPT-EF208C-BDWW	OPT-EF208D-BDWW	
	Barn Doors - Black	OPT-EF208B-BDBB	OPT-EF208C-BDBB	OPT-EF208D-BDBB	
	Diffused Lens	OPT-EF208B-P-DFL	OPT-EF208C-P-DFL	OPT-EF208D-P-DFL	
	Linear Spread Lens	OPT-EF208B-P-LSL	OPT-EF208C-P-LSL	OPT-EF208D-P-LSL	
	Reflector	Narrow Beam	OPT-EF208B-REFLN	OPT-EF208C-REFLN	OPT-EF208D-REFLN
		Medium Beam	OPT-EF208B-REFLM	OPT-EF208C-REFLM	OPT-EF208D-REFLM
		Wide Beam	OPT-EF208B-REFLW	OPT-EF208C-REFLW	OPT-EF208D-REFLW
		Very Wide Beam	OPT-EF208B-REFLV	N/A	OPT-EF208D-REFLV

PROJECT	TYPE	CATALOG NUMBER
---------	------	----------------

ELECTRICAL COMPONENTS

EF4FD
POWER STARTER FEED
Electrical Component

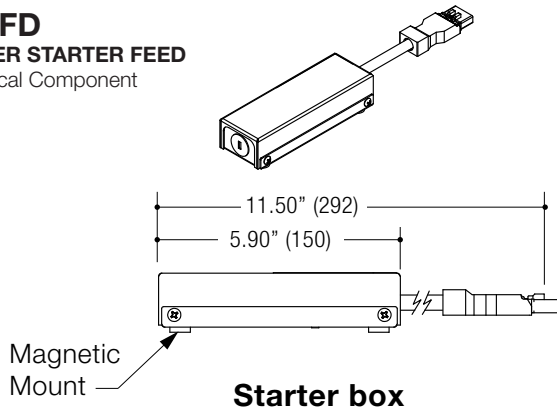

Starter box

EFXJW
JUMPER WIRE
Electrical Component

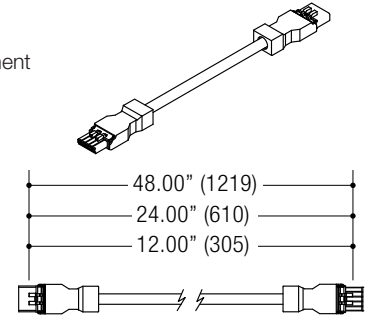

Jumper Wire

ORDERING INFO

SERIES	VOLTAGE	FINISH
EF4FD Power Starter Feed	U 5 Wire / 0-10V Capable	BB Black WW White

Ordering Example: **EF4FD-U-BB**

ORDERING INFO



SERIES	DESCRIPTION	VOLTAGE	FINISH
EFXJW Jumper Wire	012 Jumper Wire 1' 024 Jumper Wire 2' 048 Jumper Wire 4'	U 5 Wire / 0-10V Capable	BB Black WW White

Ordering Example: **EFXJW-024-U-BB**

TYPICAL COMPONENT INSTALLATION

