

PROJECT	TYPE	CATALOG NUMBER
---------	------	----------------

## Specifications

### SPOTLIGHT

- 3.90" diameter cylinder
- 125° x 125° arm articulation - Friction lock
- 90° x 90° head rotation - Friction lock
- Die-cast aluminum optical housing
- Articulating arm allows for greater aiming
- Powder coat finish

### LED SOURCE

- Field-replaceable integral LED module
- Field-changeable optic
- Easy access via front ring snap-in catch action
- 19W / 1920lm (@ 80CRI / 3000K) Passive
- 26W / 2543lm (@ 80CRI / 3000K) Passive
- 34W / 3097lm (@ 80CRI / 3000K) Passive
- Accepts 1 or more optical accessories

### ELECTRICAL

- Field-replaceable LED driver
- Dimmable

### MOUNTING

- Fabricated steel extension arm
- Side channel magnetic mount
- Designed for EF400 - EF4CNS Channel

### LABELS

- Suitable for damp location

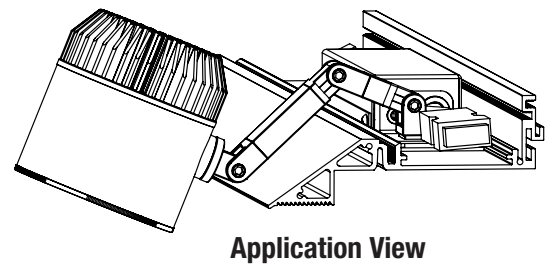
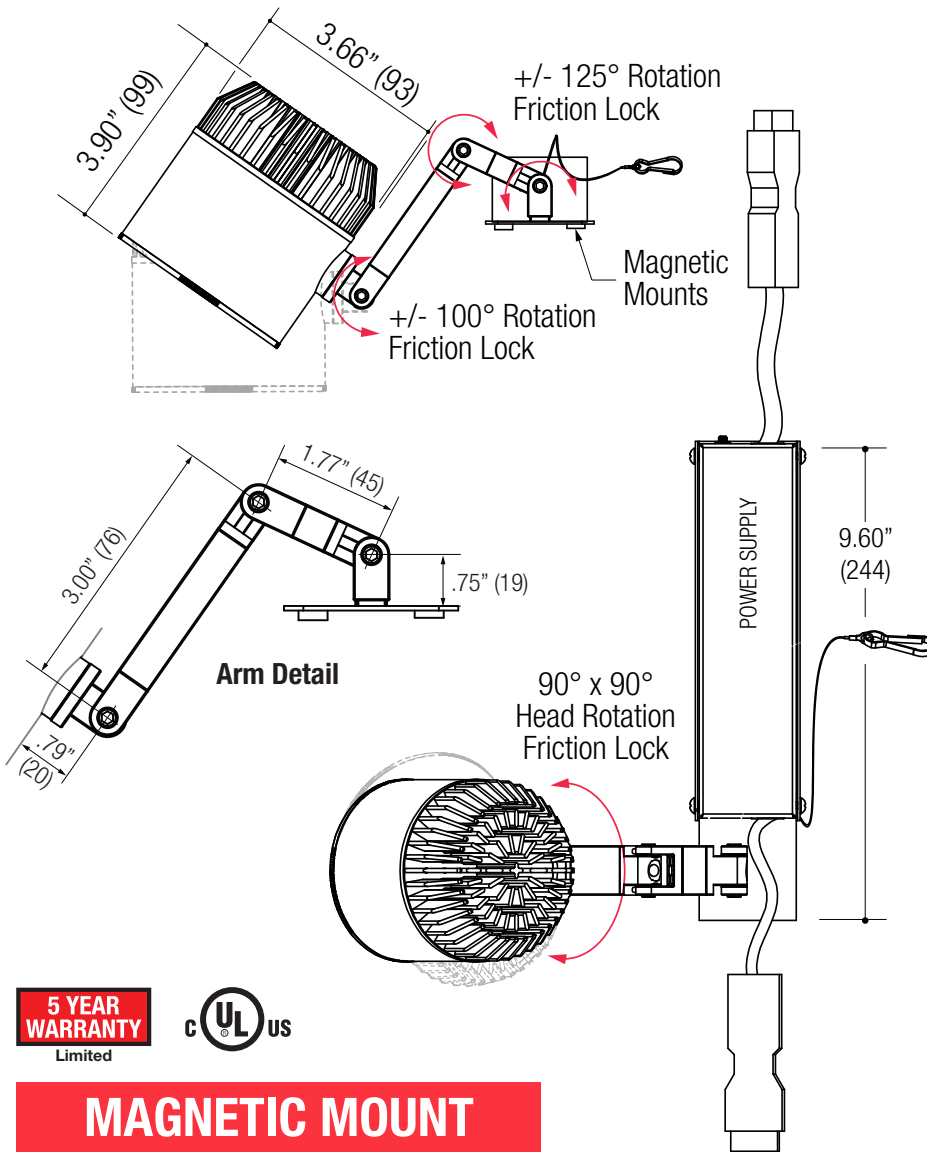

**5 YEAR WARRANTY**  
Limited







## MAGNETIC MOUNT

### ORDERING INFO

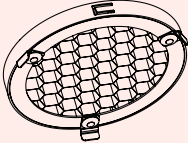
SERIES	WATTAGE	CRI / COLOR	BEAM	DRIVER	FINISH
<b>EF408C</b>	<b>19C</b> 19W LED 1920 lm nom	<b>8027</b> 80CRI / 2700K	<b>N</b> Narrow 14° <b>M</b> Medium 24° <b>W</b> Wide 42°	<b>DMU</b> Dimming Multiple Forward/Reverse Phase (@ 120V only) 0-10V Wires Present (@ 120-277V)	<b>BB</b> Black <b>WW</b> White
		<b>8030</b> 80CRI / 3000K			
<b>EF400</b> <b>Cylindrical Medium</b> Die Cast Aluminum Housing Variable Adjustment EF400 - EF4CNS Channel Mount	<b>26C</b> 26W LED 2543 lm nom.	<b>8035</b> 80CRI / 3500K		* Larger power supply case may be required. Depending on wattage - Consult factory for details	Consult factory for custom colors. Minimum order required. Bezels only available in black or white.
		<b>8040</b> 80CRI / 4000K			
		<b>8050</b> 80CRI / 5000K			
		<b>9227</b> 92CRI / 2700K			
		<b>9230</b> 92CRI / 3000K			
		<b>9235</b> 92CRI / 3500K			
		<b>9240</b> 92CRI / 4000K			

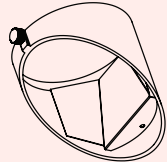
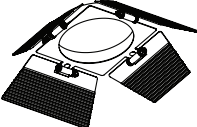
Ordering Example: **EF408C-26C-8030-N-DMU-BB**

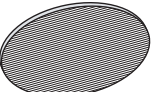
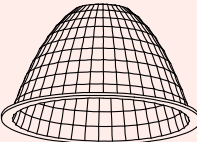
OPTICAL ACCESSORY	DESCRIPTION	LED SOURCE		
		EF208B / EF408B	EF208C / EF408C	EF208D / EF408D
		<ul style="list-style-type: none"> <li>• 09W LED</li> <li>• 14W LED</li> <li>• 21W LED</li> <li>• 28W LED</li> </ul>	<ul style="list-style-type: none"> <li>• 28W LED</li> <li>• 35W LED</li> <li>• 41W LED</li> </ul>	<ul style="list-style-type: none"> <li>• 34W LED</li> <li>• 40W LED</li> <li>• 55W LED</li> </ul>
	Hex Cell Louver - Black	OPT-EF208B-HXL	OPT-EF208C-HXL	OPT-EF208D-HXL
	Snoot with Cross Baffle White	OPT-EF208B-CBWW	OPT-EF208C-CBWW	OPT-EF208D-CBWW
	Snoot with Cross Baffle Black	OPT-EF208B-CBBB	OPT-EF208C-CBBB	OPT-EF208D-CBBB
	Wallwash - White	OPT-EF208B-WWWW	OPT-EF208C-WWWW	OPT-EF208D-WWWW
	Wallwash - Black	OPT-EF208B-WWBB	OPT-EF208C-WWBB	OPT-EF208D-WWBB
	Barn Doors - White	OPT-EF208B-BDWW	OPT-EF208C-BDWW	OPT-EF208D-BDWW
	Barn Doors - Black	OPT-EF208B-BDBB	OPT-EF208C-BDBB	OPT-EF208D-BDBB
	Diffused Lens	OPT-EF208B-P-DFL	OPT-EF208C-P-DFL	OPT-EF208D-P-DFL
	Linear Spread Lens	OPT-EF208B-P-LSL	OPT-EF208C-P-LSL	OPT-EF208D-P-LSL
	Narrow Beam	OPT-EF208B-REFLN	OPT-EF208C-REFLN	OPT-EF208D-REFLN
	Medium Beam	OPT-EF208B-REFLM	OPT-EF208C-REFLM	OPT-EF208D-REFLM
	Wide Beam	OPT-EF208B-REFLW	OPT-EF208C-REFLW	OPT-EF208D-REFLW
	Very Wide Beam	OPT-EF208B-REFLV	N/A	OPT-EF208D-REFLV

PROJECT	TYPE	CATALOG NUMBER
---------	------	----------------

### ELECTRICAL COMPONENTS

#### EF4FD POWER STARTER FEED Electrical Component

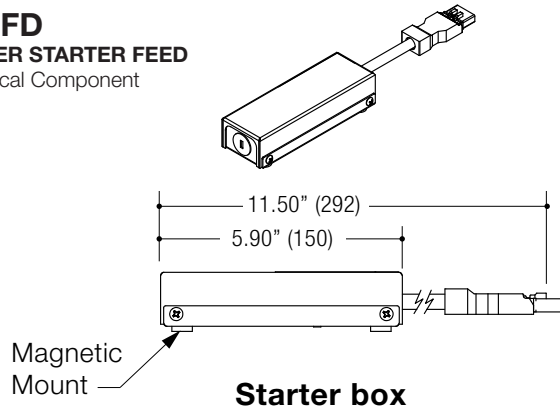

#### EFXJW JUMPER WIRE Electrical Component

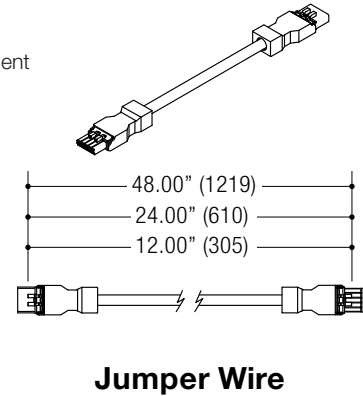

#### ORDERING INFO

SERIES	VOLTAGE	FINISH
<b>EF4FD</b> Power Starter Feed	<b>U</b> 5 Wire / 0-10V Capable	<b>BB</b> Black <b>WW</b> White

Ordering Example: **EF4FD-U-BB**

#### ORDERING INFO



SERIES	DESCRIPTION	VOLTAGE	FINISH
<b>EFXJW</b> Jumper Wire	<b>012</b> Jumper Wire 1' <b>024</b> Jumper Wire 2' <b>048</b> Jumper Wire 4'	<b>U</b> 5 Wire / 0-10V Capable	<b>BB</b> Black <b>WW</b> White

Ordering Example: **EFXJW-024-U-BB**

### TYPICAL COMPONENT INSTALLATION

