

CYLINDRICAL

LED

LARGE

PROJECT	TYPE	CATALOG NUMBER
---------	------	----------------

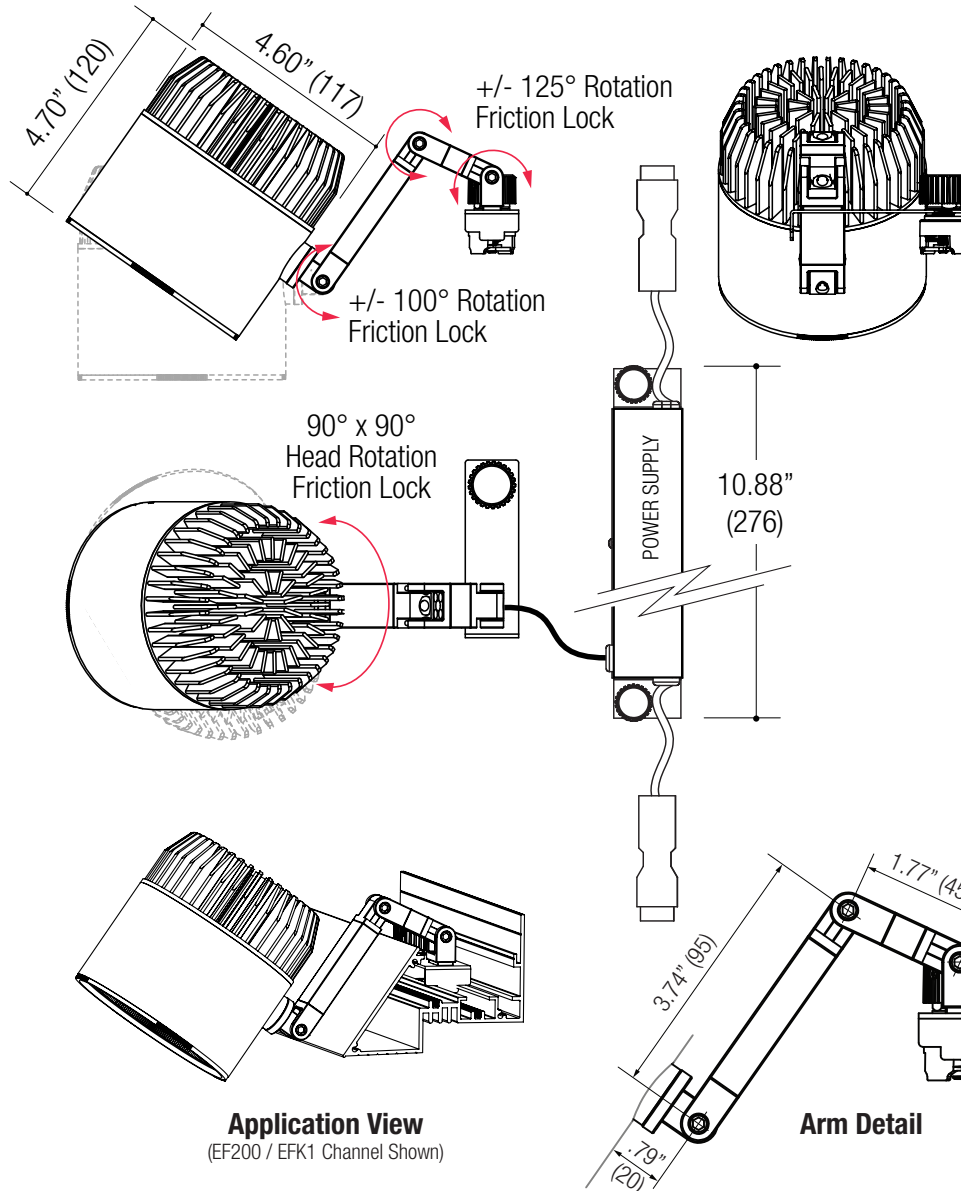

SPOTLIGHT

- 4.60" diameter cylinder
- 125° x 125° arm articulation - Friction lock
- 90° x 90° head rotation - Friction lock
- Die-cast aluminum optical housing
- Articulating arm allows for greater aiming
- Powder coat finish

LED SOURCE

- Field-replaceable integral LED module
- Field-changeable optic
- Easy access via front ring snap-in catch action.
- 34W / 2727lm (@ 80CRI / 3000K) Passive
- 40W / 3477lm (@ 80CRI / 3000K) Passive
- Accepts 1 or more optical accessories

ELECTRICAL

- Field-replaceable LED driver
- Dimmable

MOUNTING

- Fabricated steel extension arm
- Snap in, twist-lock mounting
- EF200 / EFK1 Single channel (*Sold Separately*)
- EF200 / EFK2 Dual channel (*Sold Separately*)

LABELS

- Suitable for damp location

Application View
(EF200 / EFK1 Channel Shown)

Arm Detail

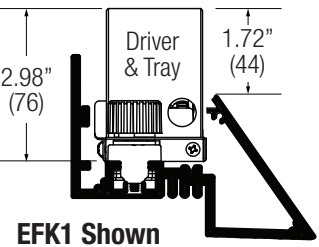

EFK1 Shown

5 YEAR WARRANTY
Limited



ORDERING INFO

SERIES	WATTAGE	CRI / COLOR	BEAM	DRIVER	FINISH
EF208D	34C 34W LED 2727 lm del.	8027 80CRI / 2700K 8030 80CRI / 3000K 8035 80CRI / 3500K 8040 80CRI / 4000K 8050 80CRI / 5000K	N Narrow 15° M Medium 27° W Wide 42° V Very Wide 58°	DMU Dimming Multiple Forward/Reverse Phase (@ 120V only) 0-10V Wires Present (@ 120-277V)	BB Black WW White Consult factory for custom colors. Minimum order required. Bezels only available in black or white.
EF200 Cylindrical Large Die Cast Aluminum Housing Variable Adjustment EFK1 & EFK2 Channel Mount	40C* 40W LED 3477 lm del. * Larger power supply case may be required. Depending on wattage - Consult factory for details	9527 95CRI / 2700K 9530 95CRI / 3000K 9535 95CRI / 3500K 9540 95CRI / 4000K 9550 95CRI / 5000K			

Ordering Example: **EF208D-40C-9527-N-DMU-BB**

©2018 LF ILLUMINATION LLC

We reserve the right to change or withdraw specifications without prior notice.

HEADQUARTERS

9200 Deering Avenue
Chatsworth CA 91311



Telephone: 818-885-1335

Toll Free: 855-885-1335

Fax: 818-576-1335

www.lfillumination.com

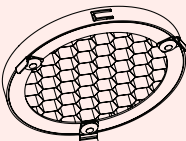
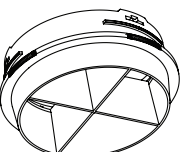
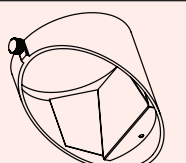
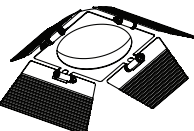
rev: 042618

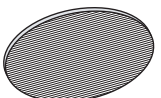
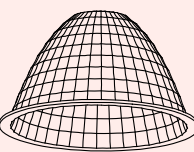
OPTICAL ACCESSORY	DESCRIPTION	LED SOURCE			
		EF208B / EF408B	EF208C / EF408C	EF208D / EF408D	
		LED	LED	LED	
	Hex Cell Louver - Black	OPT-EF208B-HXL	OPT-EF208C-HXL	OPT-EF208D-HXL	
	Snoot with Cross Baffle White	OPT-EF208B-CBWW	OPT-EF208C-CBWW	OPT-EF208D-CBWW	
	Snoot with Cross Baffle Black	OPT-EF208B-CBBB	OPT-EF208C-CBBB	OPT-EF208D-CBBB	
	Wallwash - White	OPT-EF208B-WWWW	OPT-EF208C-WWWW	OPT-EF208D-WWWW	
	Wallwash - Black	OPT-EF208B-WWBB	OPT-EF208C-WWBB	OPT-EF208D-WWBB	
	Barn Doors - White	OPT-EF208B-BDWW	OPT-EF208C-BDWW	OPT-EF208D-BDWW	
	Barn Doors - Black	OPT-EF208B-BDBB	OPT-EF208C-BDBB	OPT-EF208D-BDBB	
	Diffused Lens	OPT-EF208B-P-DFL	OPT-EF208C-P-DFL	OPT-EF208D-P-DFL	
	Linear Spread Lens	OPT-EF208B-P-LSL	OPT-EF208C-P-LSL	OPT-EF208D-P-LSL	
	Reflector	Narrow Beam	OPT-EF208B-REFLN	OPT-EF208C-REFLN	OPT-EF208D-REFLN
		Medium Beam	OPT-EF208B-REFLM	OPT-EF208C-REFLM	OPT-EF208D-REFLM
		Wide Beam	OPT-EF208B-REFLW	OPT-EF208C-REFLW	OPT-EF208D-REFLW
		Very Wide Beam	OPT-EF208B-REFLV	N/A	OPT-EF208D-REFLV

PROJECT

TYPE

CATALOG NUMBER

ELECTRICAL COMPONENTS

EFXFD
POWER STARTER FEED
 Electrical Component

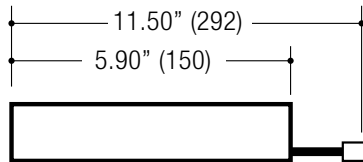

EFXJW
JUMPER WIRE
 Electrical Component

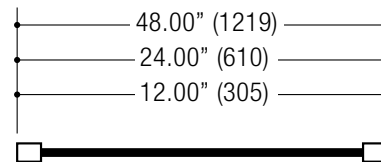

Jumper Wire

ORDERING INFO

SERIES	VOLTAGE	FINISH
EFXFD Power Starter Feed	U 5 Wire / 0-10V Capable	BB Black WW White

Ordering Example: **EFXFD-U-BB**

ORDERING INFO



SERIES	DESCRIPTION	VOLTAGE	FINISH
EFXJW Jumper Wire	012 Jumper Wire 1' 024 Jumper Wire 2' 048 Jumper Wire 4'	U 5 Wire / 0-10V Capable	BB Black WW White

Ordering Example: **EFXJW-024-U-BB**

TYPICAL COMPONENT INSTALLATION

