

PROJECT	TYPE	CATALOG NUMBER
---------	------	----------------

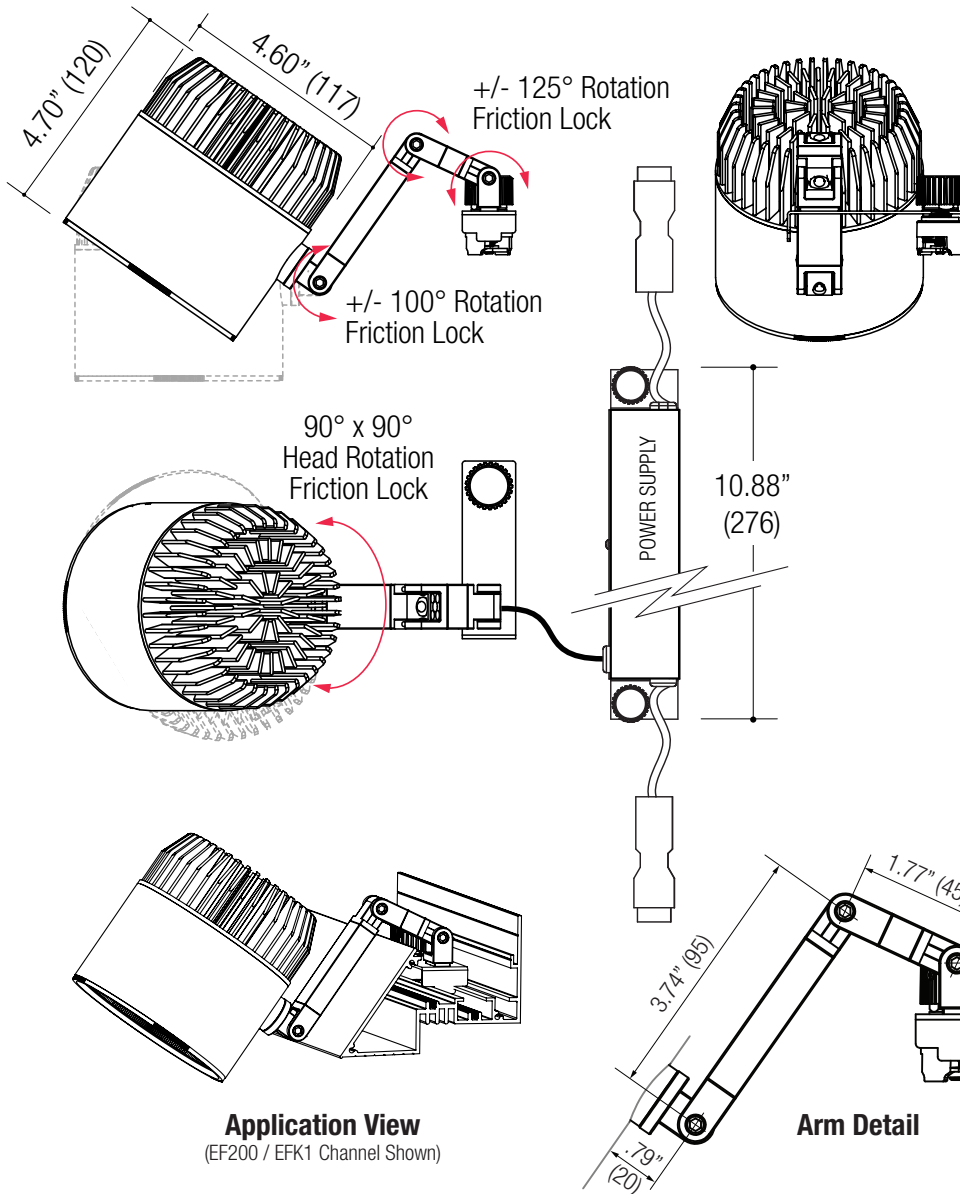

## Specifications

### SPOTLIGHT

- 4.60" diameter cylinder
- 125° x 125° arm articulation - Friction lock
- 90° x 90° head rotation - Friction lock
- Die-cast aluminum optical housing
- Articulating arm allows for greater aiming
- Powder coat finish

### LED SOURCE

- Field-replaceable integral LED module
- Field-changeable optic
- CREE
- Easy access via front ring snap-in catch action
- Accepts 1 or more optical accessories

### ELECTRICAL

- Field-replaceable LED driver
- Dimmable

### MOUNTING

- Fabricated steel extension arm
- Snap in, twist-lock mounting
- EF200 / EFK1 Single channel (*Sold Separately*)
- EF200 / EFK2 Dual channel (*Sold Separately*)

### LABELS



- Suitable for damp location



### ORDERING INFO

SERIES	WATTAGE	CRI / COLOR	BEAM	DRIVER	FINISH
<b>EF208D</b>	<b>34C</b> 34W LED 2727 lm del.	<b>8027</b> 80CRI / 2700K <b>8030</b> 80CRI / 3000K <b>8035</b> 80CRI / 3500K <b>8040</b> 80CRI / 4000K	<b>N</b> Narrow 15° <b>M</b> Medium 27° <b>W</b> Wide 42° <b>V</b> Very Wide 58°	<b>DMU</b> Dimming Multiple Forward/Reverse Phase (@ 120V only) 0-10V Wires Present (@ 120-277V)	<b>BB</b> Black <b>WW</b> White
<b>EF200 Cylindrical Large</b> Die Cast Aluminum Housing Variable Adjustment EFK1 & EFK2 Channel Mount	<b>40C</b> 40W LED 3477 lm del. Delivered @ 80CRI / 3000K Narrow Beam	<b>9227</b> 92CRI / 2700K <b>9230</b> 92CRI / 3000K <b>9235</b> 92CRI / 3500K <b>9240</b> 92CRI / 4000K			Consult factory for custom colors. Minimum order required. Bezels only available in black or white.

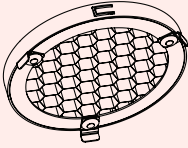
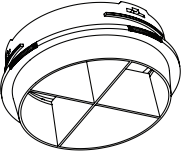
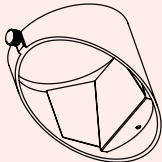
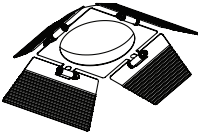
Ordering Example: **EF208D-40C-9227-N-DMU-BB**

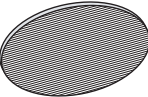
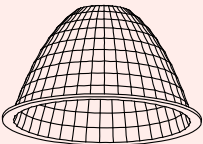
OPTICAL ACCESSORY	DESCRIPTION	LED SOURCE			
		EF208B / EF408B	EF208C / EF408C	EF208D / EF408D	
	Hex Cell Louver - Black	OPT-EF208B-HXL	OPT-EF208C-HXL	OPT-EF208D-HXL	
	Snoot with Cross Baffle White	OPT-EF208B-CBWW	OPT-EF208C-CBWW	OPT-EF208D-CBWW	
	Snoot with Cross Baffle Black	OPT-EF208B-CBBB	OPT-EF208C-CBBB	OPT-EF208D-CBBB	
	Wallwash - White	OPT-EF208B-WWWW	OPT-EF208C-WWWW	OPT-EF208D-WWWW	
	Wallwash - Black	OPT-EF208B-WWBB	OPT-EF208C-WWBB	OPT-EF208D-WWBB	
	Barn Doors - White	OPT-EF208B-BDWW	OPT-EF208C-BDWW	OPT-EF208D-BDWW	
	Barn Doors - Black	OPT-EF208B-BDBB	OPT-EF208C-BDBB	OPT-EF208D-BDBB	
	Diffused Lens	OPT-EF208B-P-DFL	OPT-EF208C-P-DFL	OPT-EF208D-PDFL	
	Linear Spread Lens	OPT-EF208B-P-LSL	OPT-EF208C-P-LSL	OPT-EF208D-P-LSL	
	Reflector	Narrow Beam	OPT-EF208B-REFLN	OPT-EF208C-REFLN	OPT-EF208D-REFLN
		Medium Beam	OPT-EF208B-REFLM	OPT-EF208C-REFLM	OPT-EF208D-REFLM
		Wide Beam	OPT-EF208B-REFLW	OPT-EF208C-REFLW	OPT-EF208D-REFLW
		Very Wide Beam	OPT-EF208B-REFLV	N/A	OPT-EF208D-REFLV

PROJECT	TYPE	CATALOG NUMBER
---------	------	----------------

### ELECTRICAL COMPONENTS

**EFXFD**  
**POWER STARTER FEED**  
 Electrical Component

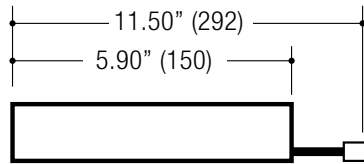

**Starter Box**

**EFXJW**  
**JUMPER WIRE**  
 Electrical Component

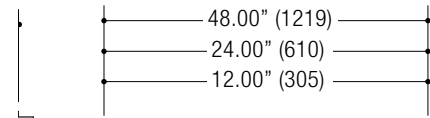
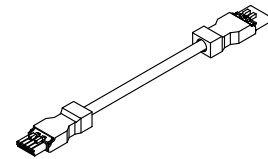

#### ORDERING INFO

SERIES	VOLTAGE	FINISH
<b>EFXFD</b> Power Starter Feed	<b>U</b> 5 Wire / 0-10V Capable	<b>BB</b> Black <b>WW</b> White

Ordering Example: **EFXFD-U-BB**

#### ORDERING INFO

SERIES	DESCRIPTION	VOLTAGE	FINISH
<b>EFXJW</b> Jumper Wire	<b>012</b> Jumper Wire 1' <b>024</b> Jumper Wire 2' <b>048</b> Jumper Wire 4'	<b>U</b> 5 Wire / 0-10V Capable	<b>BB</b> Black <b>WW</b> White

Ordering Example: **EFXJW-024-U-BB**



### TYPICAL COMPONENT INSTALLATION

