

CYLINDRICAL

LED

SMALL

PROJECT	TYPE	CATALOG NUMBER
---------	------	----------------

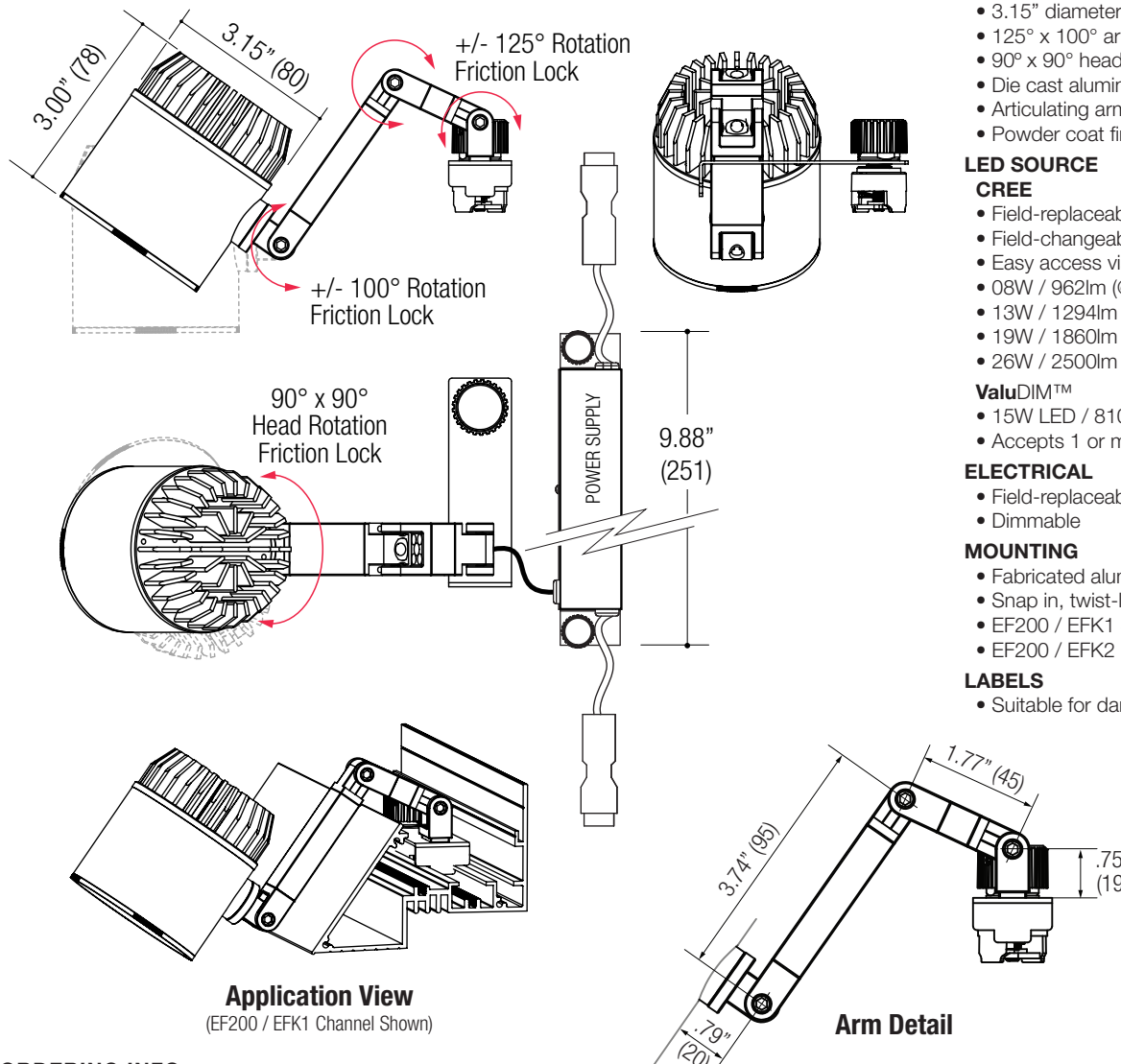

SPOTLIGHT

- 3.15" diameter cylinder
- 125° x 100° arm articulation - Friction lock
- 90° x 90° head rotation - Friction lock
- Die cast aluminum optical housing
- Articulating arm allows for greater aiming
- Powder coat finish

LED SOURCE

CREE

- Field-replaceable integral LED module
- Field-changeable optic
- Easy access via front ring snap-in catch action.
- 08W / 962lm (@ 80CRI min / 3000K) Passive
- 13W / 1294lm (@ 80CRI min / 3000K) Passive
- 19W / 1860lm (@ 80CRI min / 3000K) Passive
- 26W / 2500lm (@ 80CRI min / 3000K) Passive

ValuDIM™

- 15W LED / 810lm 3000-2000K Warm Dimming
- Accepts 1 or more optical accessories

ELECTRICAL

- Field-replaceable LED driver
- Dimmable

MOUNTING

- Fabricated aluminum extension arm
- Snap in, twist-lock mounting
- EF200 / EFK1 Single channel (*Sold Separately*)
- EF200 / EFK2 Dual channel (*Sold Separately*)

LABELS

- Suitable for damp location

Application View
(EF200 / EFK1 Channel Shown)

Arm Detail



5 YEAR WARRANTY
Limited



ORDERING INFO

SERIES	WATTAGE	CRI / COLOR	BEAM	DRIVER	VOLTAGE	FINISH
EF208B EF200 Cylindrical Small Die Cast Aluminum Housing Variable Adjustment EFK1 & EFK2 Channel Mount	08C 08W LED 962 lm nom.	8027 80CRI / 2700K 8030 80CRI / 3000K	N Narrow 13° M Medium 22° W Wide 30° V Very Wide 50°	D1 Phase Dimming (120V only) D2 0-10V Dimming (120-277V only)	1 120V U 120-277V	BB Black WW White XX Custom
	13C 13W LED 1294 lm nom.	8035 80CRI / 3500K 8040 80CRI / 4000K				
	19C 19W LED 1860 lm nom.	8050 80CRI / 5000K 9527 95CRI / 2700K				
	26C 26W LED 2500 lm nom.	9530 95CRI / 3000K 9535 95CRI / 3500K				
	ValuDIM™ 15V 15W LED / 810lm nom. 3000-2000K Warm Dimming	9220 92CRI / 3000-2000K Warm Dimming (ValuDIM Only)				

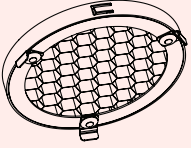
Ordering Example: **EF208B-13C-9527-N-D2-U-BB**

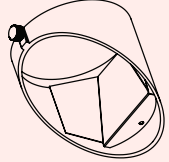
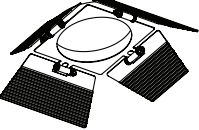
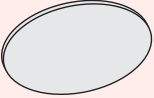
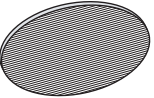
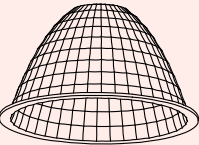
OPTICAL ACCESSORY	DESCRIPTION	LED SOURCE			
		EF208B / EF408B	EF208C / EF408C	EF208D / EF408D	
		<ul style="list-style-type: none"> • 09W LED • 14W LED • 21W LED • 28W LED 	<ul style="list-style-type: none"> • 28W LED • 35W LED • 41W LED 	<ul style="list-style-type: none"> • 34W LED • 40W LED • 55W LED 	
	Hex Cell Louver - Black	OPT-EF208B-HXL	OPT-EF208C-HXL	OPT-EF208D-HXL	
	Snoot with Cross Baffle White	OPT-EF208B-CBWW	OPT-EF208C-CBWW	OPT-EF208D-CBWW	
	Snoot with Cross Baffle Black	OPT-EF208B-CBBB	OPT-EF208C-CBBB	OPT-EF208D-CBBB	
	Wallwash - White	OPT-EF208B-WWWW	OPT-EF208C-WWWW	OPT-EF208D-WWWW	
	Wallwash - Black	OPT-EF208B-WWBB	OPT-EF208C-WWBB	OPT-EF208D-WWBB	
	Barn Doors - White	OPT-EF208B-BDWW	OPT-EF208C-BDWW	OPT-EF208D-BDWW	
	Barn Doors - Black	OPT-EF208B-BDBB	OPT-EF208C-BDBB	OPT-EF208D-BDBB	
	Diffused Lens	OPT-EF208B-P-DFL	OPT-EF208C-P-DFL	OPT-EF208D-P-DFL	
	Linear Spread Lens	OPT-EF208B-P-LSL	OPT-EF208C-P-LSL	OPT-EF208D-P-LSL	
	Reflector	Narrow Beam	OPT-EF208B-REFLN	OPT-EF208C-REFLN	OPT-EF208D-REFLN
		Medium Beam	OPT-EF208B-REFLM	OPT-EF208C-REFLM	OPT-EF208D-REFLM
		Wide Beam	OPT-EF208B-REFLW	OPT-EF208C-REFLW	OPT-EF208D-REFLW
		Very Wide Beam	OPT-EF208B-REFLV	N/A	OPT-EF208D-REFLV

PROJECT

TYPE

CATALOG NUMBER

ELECTRICAL COMPONENTS

EFXFD
POWER STARTER FEED
 Electrical Component

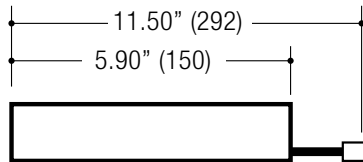

EFXJW
JUMPER WIRE
 Electrical Component

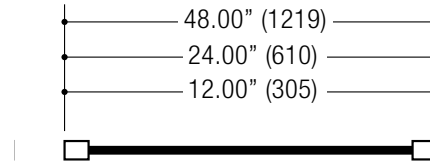

ORDERING INFO

SERIES	VOLTAGE	FINISH
EFXFD Power Starter Feed	U 5 Wire / 0-10V Capable	BB Black WW White

Ordering Example: **EFXFD-U-BB**

ORDERING INFO



SERIES	DESCRIPTION	VOLTAGE	FINISH
EFXJW Jumper Wire	012 Jumper Wire 1' 024 Jumper Wire 2' 048 Jumper Wire 4'	U 5 Wire / 0-10V Capable	BB Black WW White

Ordering Example: **EFXJW-024-U-BB**

TYPICAL COMPONENT INSTALLATION

