

PROJECT	TYPE	CATALOG NUMBER
---------	------	----------------

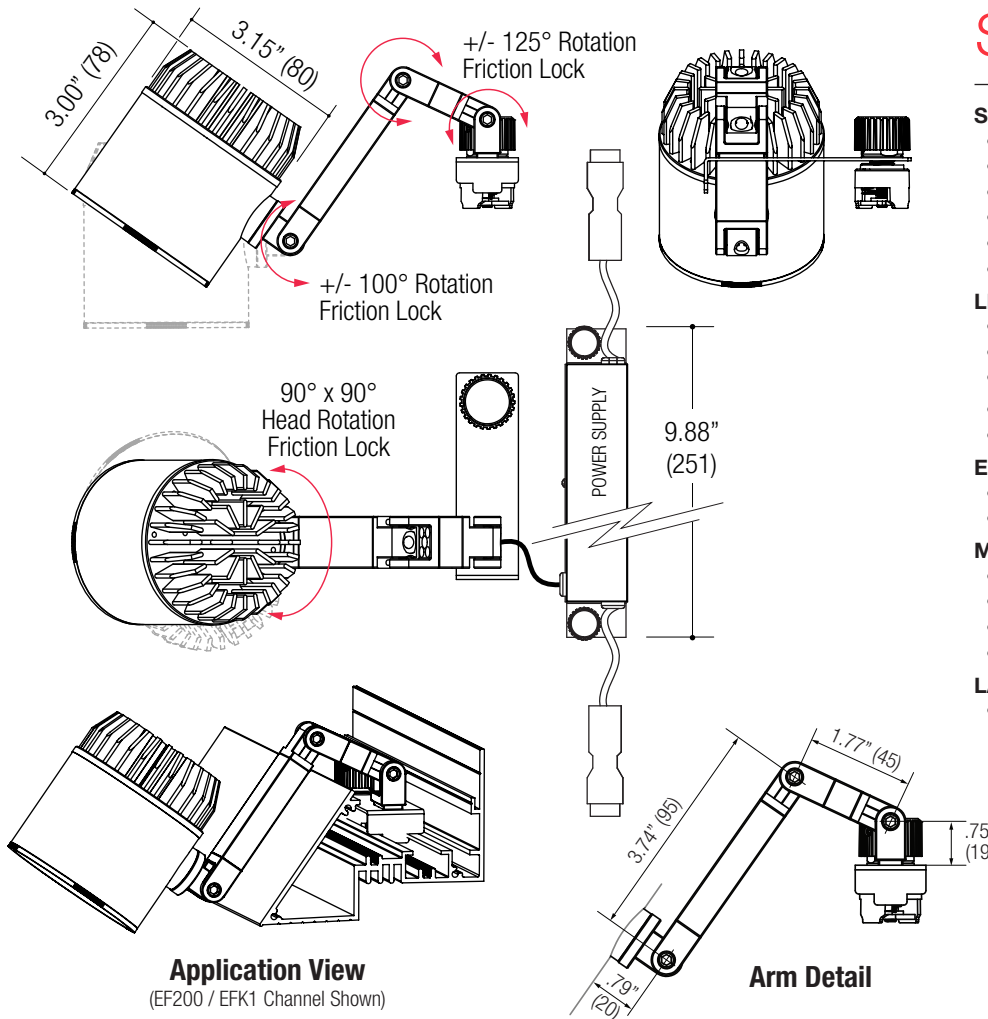

Specifications

SPOTLIGHT

- 3.15" diameter cylinder
- 125° x 100° arm articulation - Friction lock
- 90° x 90° head rotation - Friction lock
- Die cast aluminum optical housing
- Articulating arm allows for greater aiming
- Powder coat finish

LED SOURCE

- Field-replaceable integral LED module
- Field-changeable optic
- Easy access via front ring snap-in catch action.
- CREE / ValuDIM™
- Accepts 1 or more optical accessories

ELECTRICAL

- Field-replaceable LED driver
- Dimmable

MOUNTING

- Fabricated aluminum extension arm
- Snap in, twist-lock mounting
- EF200 / EFK1 Single channel *(Sold Separately)*
- EF200 / EFK2 Dual channel *(Sold Separately)*

LABELS

- Suitable for damp location



Application View
(EF200 / EFK1 Channel Shown)



Arm Detail



ORDERING INFO

SERIES	WATTAGE	CRI / COLOR	BEAM	DRIVER	FINISH
EF208B	08C 08W LED 982 lm del.	8027 80CRI / 2700K	N Narrow 13°	DMU Dimming Multiple Forward/Reverse Phase (@ 120V only) 0-10V Wires Present (@ 120-277V)	BB Black WW White Consult factory for custom colors. Minimum order required. Bezels only available in black or white.
	13C 13W LED 1322 lm del.	8030 80CRI / 3000K	M Medium 22°		
	19C 19W LED 1900 lm del.	8035 80CRI / 3500K	W Wide 30°		
	26C 26W LED 2555 lm del. Delivered @ 80CRI / 3000K Narrow Beam	8040 80CRI / 4000K	V Very Wide 50°		
	ValuDIM™ 15V 15W LED / 874lm del. 3000-1800K Warm Dimming Delivered @ 92CRI / 3000K Narrow Beam	9227 92CRI / 2700K 9230 92CRI / 3000K 9235 92CRI / 3500K 9240 92CRI / 4000K			

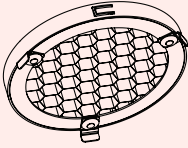
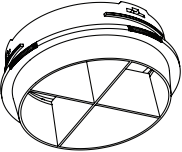
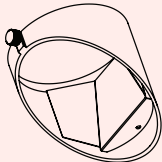
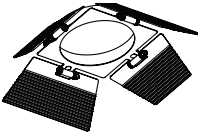
Ordering Example: **EF208B-13C-8030-N-DMU-BB**

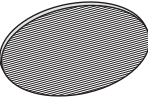
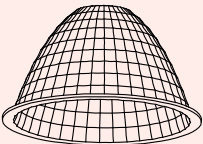
OPTICAL ACCESSORY	DESCRIPTION	LED SOURCE			
		EF208B / EF408B	EF208C / EF408C	EF208D / EF408D	
	Hex Cell Louver - Black	OPT-EF208B-HXL	OPT-EF208C-HXL	OPT-EF208D-HXL	
	Snoot with Cross Baffle White	OPT-EF208B-CBWW	OPT-EF208C-CBWW	OPT-EF208D-CBWW	
	Snoot with Cross Baffle Black	OPT-EF208B-CBBB	OPT-EF208C-CBBB	OPT-EF208D-CBBB	
	Wallwash - White	OPT-EF208B-WWWW	OPT-EF208C-WWWW	OPT-EF208D-WWWW	
	Wallwash - Black	OPT-EF208B-WWBB	OPT-EF208C-WWBB	OPT-EF208D-WWBB	
	Barn Doors - White	OPT-EF208B-BDWW	OPT-EF208C-BDWW	OPT-EF208D-BDWW	
	Barn Doors - Black	OPT-EF208B-BDBB	OPT-EF208C-BDBB	OPT-EF208D-BDBB	
	Diffused Lens	OPT-EF208B-P-DFL	OPT-EF208C-P-DFL	OPT-EF208D-PDFL	
	Linear Spread Lens	OPT-EF208B-P-LSL	OPT-EF208C-P-LSL	OPT-EF208D-P-LSL	
	Reflector	Narrow Beam	OPT-EF208B-REFLN	OPT-EF208C-REFLN	OPT-EF208D-REFLN
		Medium Beam	OPT-EF208B-REFLM	OPT-EF208C-REFLM	OPT-EF208D-REFLM
		Wide Beam	OPT-EF208B-REFLW	OPT-EF208C-REFLW	OPT-EF208D-REFLW
		Very Wide Beam	OPT-EF208B-REFLV	N/A	OPT-EF208D-REFLV

PROJECT	TYPE	CATALOG NUMBER
---------	------	----------------

ELECTRICAL COMPONENTS

EFXFD
POWER STARTER FEED
 Electrical Component

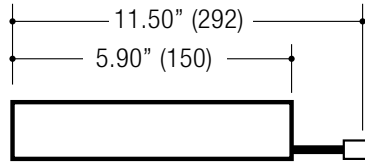

EFXJW
JUMPER WIRE
 Electrical Component

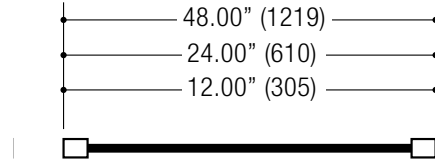

ORDERING INFO

SERIES	VOLTAGE	FINISH
EFXFD Power Starter Feed	U 5 Wire / 0-10V Capable	BB Black WW White

Ordering Example: **EFXFD-U-BB**

ORDERING INFO



SERIES	DESCRIPTION	VOLTAGE	FINISH
EFXJW Jumper Wire	012 Jumper Wire 1' 024 Jumper Wire 2' 048 Jumper Wire 4'	U 5 Wire / 0-10V Capable	BB Black WW White

Ordering Example: **EFXJW-024-U-BB**

TYPICAL COMPONENT INSTALLATION

