

PROJECT	TYPE	CATALOG NUMBER
---------	------	----------------

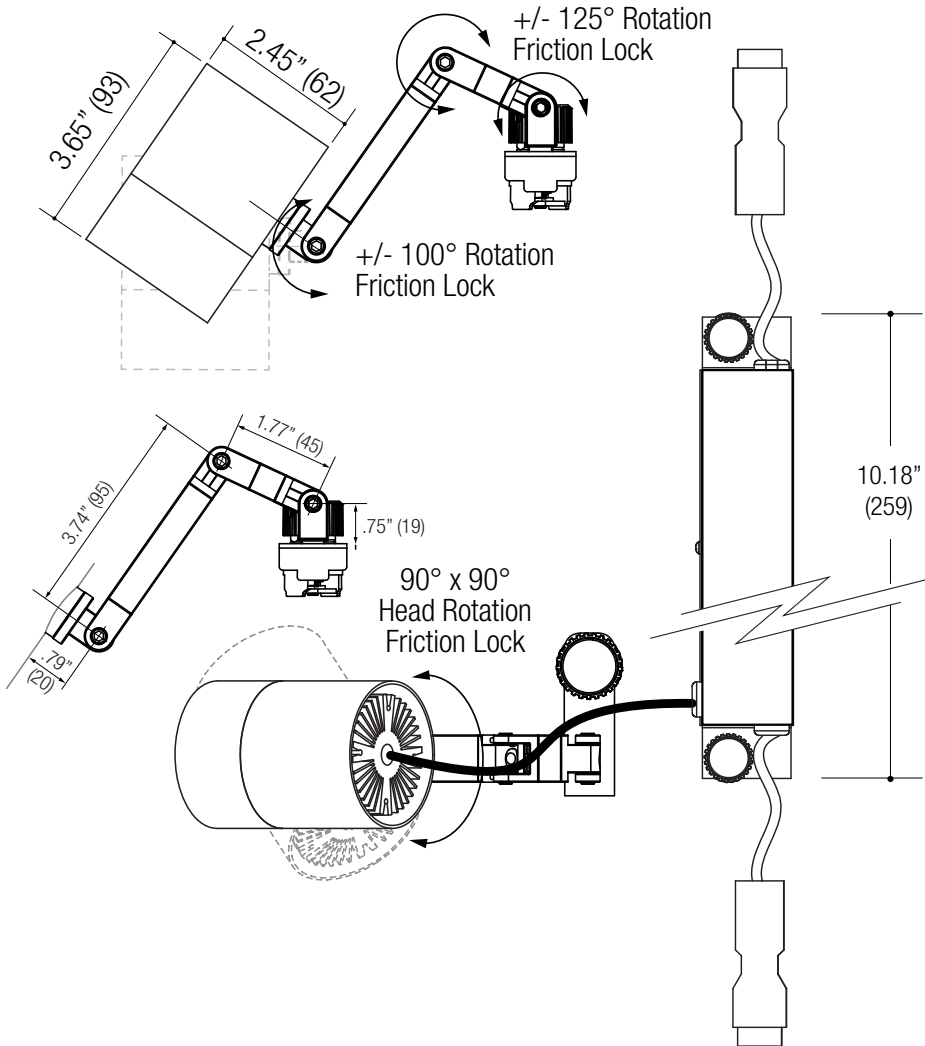

Specifications

SPOTLIGHT

- 2.45" diameter cylinder
- 125° x 100° arm articulation - Friction lock
- 90° x 90° head rotation - Friction lock
- Aluminum optical housing
- Articulating arm allows for greater aiming
- Powder coat finish

LED SOURCE (SORAA)

- SORAA optical light engine module
- Snap system compatible
- Adjustable light output application
- 07W / 650lm, 80CRI / 3000K
- 10W / 800lm, 80CRI / 3000K
- Accepts up to 2 or more optical accessories

ELECTRICAL

- Field-replaceable LED driver in tandem enclosure
- Dimmable

MOUNTING

- Die-cast aluminum extension arm
- Snap in, twist-lock mounting
- EF200 / EFK1 Single channel
(Sold Separately)
- EF200 / EFK2 Dual channel
(Sold Separately)

LABELS

- Suitable for damp location

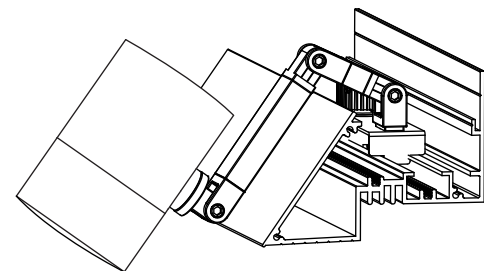

Application View
(EF200 System Channel Shown)

5 YEAR WARRANTY
Limited









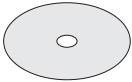

POWERED BY
SORAA

ORDERING INFO

SERIES	WATTAGE	CRI / COLOR	BEAM	DRIVER	VOLTAGE	FINISH
EF207B	07S 07W LED / 650lm nom.	8027 80CRI / 2700K 8030 80CRI / 3000K	N Narrow 9°	D1 Phase Dimming (120V only) D2 0-10V Dim. Driver (120-277V only)	1 120V U 120-277V	WW White BB Black
EF200 Cylindrical Small Aluminum Housing Variable Adjustment EFK1 & EFK2 Channel Mount	10S 10W LED / 800lm nom.	8040 80CRI / 4000K 9527 95CRI / 2700K 9530 95CRI / 3000K 9540 95CRI / 4000K				Consult factory for custom colors. Minimum order required.

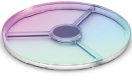
Ordering Example: **EF207B-10S-9530-N-D1-U-BB**

OPTICAL ACCESSORY	DESCRIPTION	07S and 10S
		SORAA SMALL 7W & 10W
		<ul style="list-style-type: none"> • SLX16 • SNAP SYSTEM • SORAA® LED
	Hex Cell Louver Louver Snap 40° Cutoff	OPTB-SLX16-HXL Ø2.00" (51mm) nom.
	Diffusion Lens LED Film	OPTB-SLX16-L-DFL Ø2.00" (51mm) nom.
	Linear Snap 10° x 25°	OPTB-SLX16-LSN Ø2.00" (51mm) nom.
	Linear Snap 10° x 36°	OPTB-SLX16-LSL Ø2.00" (51mm) nom.
	Linear Snap 10° x 60°	OPTB-SLX16-LSW Ø2.00" (51mm) nom.
	25° Beam Spreader Snap	OPTB-SLX16-MED25 Ø2.00" (51mm) nom.
	36° Beam Spreader Snap	OPTB-SLX16-WID36 Ø2.00" (51mm) nom.
	60° Beam Spreader Snap	OPTB-SLX16-VWD60 Ø2.00" (51mm) nom.
	1/4 CTO CCT Shifter Snap	OPTB-SLX16-14CTO Ø2.00" (51mm) nom.
	1/2 CTO CCT Shifter Snap	OPTB-SLX16-12CTO Ø2.00" (51mm) nom.
	3/4 CTO CCT Shifter Snap	OPTB-SLX16-34CTO Ø2.00" (51mm) nom.
	Flat Top 25° x 25°	OPTB-SLX16-FT2 Ø2.00" (51mm) nom.
	Flat Top 36° x 36°	OPTB-SLX16-FT3 Ø2.00" (51mm) nom.
	Clear Lens	OPTB-SLX16-CLR Ø2.00" (51mm) nom.
	Enhance Lens	OPTB-SLX16-ENH Ø2.00" (51mm) nom.
	Aimable Lens	OPTB-SLX16-AIM Ø2.00" (51mm) nom.