

PROJECT	TYPE	CATALOG NUMBER
---------	------	----------------

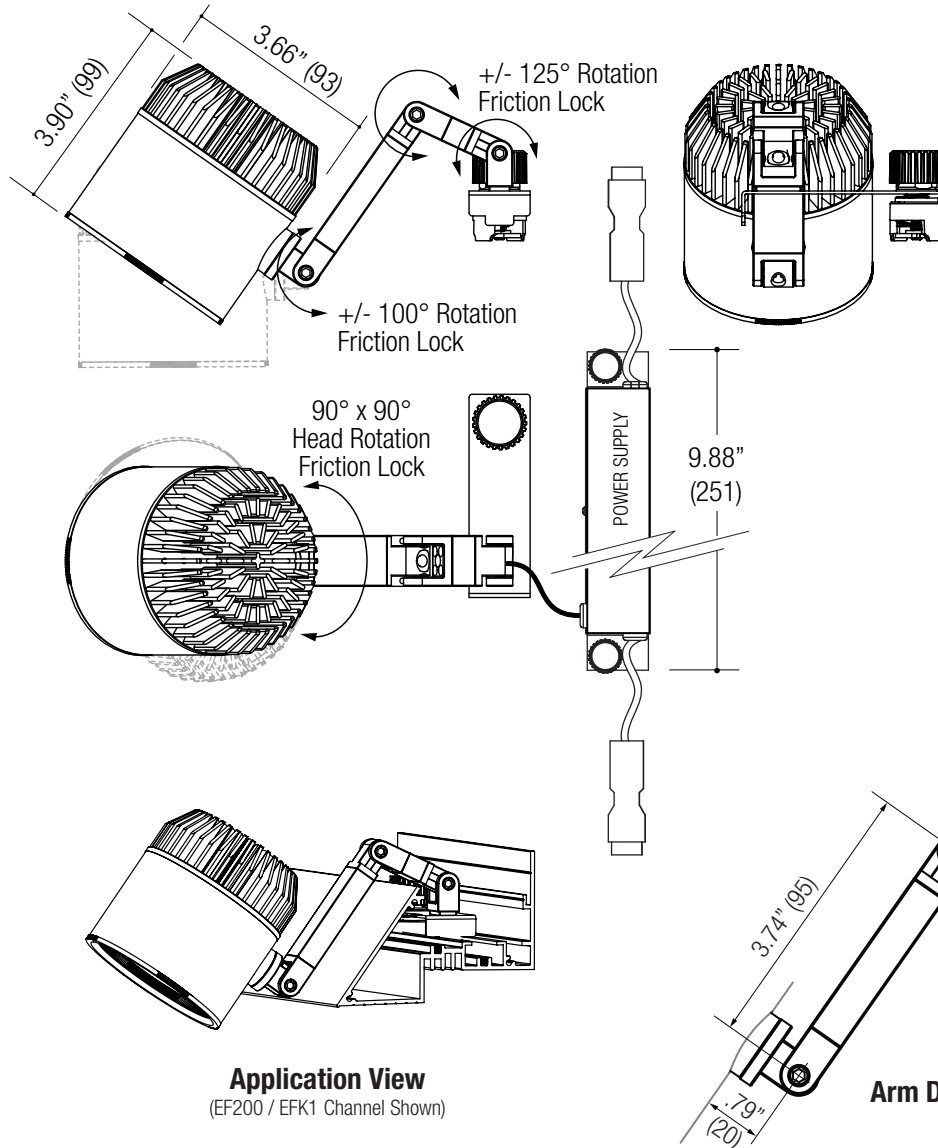

SPOTLIGHT

- 3.66" diameter cylinder
- 125° x 125° arm articulation - Friction lock
- 90° x 90° head rotation - Friction lock
- Die cast aluminum optical housing
- Articulating arm allows for greater aiming
- Powder coat finish

LED SOURCE - CREE

- Field-replaceable integral LED module
- Field-changeable optic
- Easy access via front ring snap-in catch action
- 19W / 1920lm (@ 80CRI / 3000K) Passive
- 26W / 2543lm (@ 80CRI / 3000K) Passive
- 34W / 3097lm (@ 80CRI / 3000K) Passive
- Accepts 1 or more optical accessories

ELECTRICAL

- Field-replaceable LED driver
- Dimmable

MOUNTING

- Fabricated steel extension arm
- Snap in, twist-lock mounting
- EF200 / EFK1 Single channel (*Sold Separately*)
- EF200 / EFK2 Dual channel (*Sold Separately*)

LABELS

- Suitable for damp location

Application View
(EF200 / EFK1 Channel Shown)

Arm Detail



5 YEAR WARRANTY
Limited



ORDERING INFO

SERIES	WATTAGE	CRI / COLOR	BEAM	DRIVER	FINISH
EF208C	19C 19W LED 1920 lm delivered	8027 80CRI / 2700K 8030 80CRI / 3000K	N Narrow 14° M Medium 24° W Wide 42°	DMU Dimming Multiple Forward/Reverse Phase (@ 120V only) 0-10V Wires Present (@ 120-277V)	BB Black WW White XX Custom
EF200 Cylindrical Medium Die Cast Aluminum Housing Variable Adjustment EFK1 & EFK2 Channel Mount	26C 26W LED 2543 lm delivered 34C 34W LED 3097 lm delivered Delivered @ 80CRI / 3000K Medium Beam	8035 80CRI / 3500K 8040 80CRI / 4000K 8050 80CRI / 5000K 9227 92CRI / 2700K 9230 92CRI / 3000K 9235 92CRI / 3500K 9240 92CRI / 4000K			

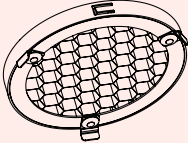
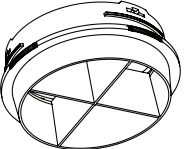
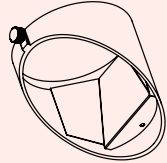
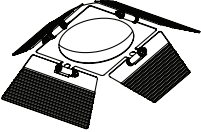
Ordering Example: **EF208C-26C-8030-N-DMU-BB**

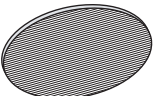
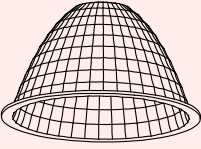
OPTICAL ACCESSORY	DESCRIPTION	LED SOURCE		
		EF208B / EF408B	EF208C / EF408C	EF208D / EF408D
		<ul style="list-style-type: none"> • 09W LED • 14W LED • 21W LED • 28W LED 	<ul style="list-style-type: none"> • 28W LED • 35W LED • 41W LED 	<ul style="list-style-type: none"> • 34W LED • 40W LED • 55W LED
	Hex Cell Louver - Black	OPT-EF208B-HXL	OPT-EF208C-HXL	OPT-EF208D-HXL
	Snoot with Cross Baffle White	OPT-EF208B-CBWW	OPT-EF208C-CBWW	OPT-EF208D-CBWW
	Snoot with Cross Baffle Black	OPT-EF208B-CBBB	OPT-EF208C-CBBB	OPT-EF208D-CBBB
	Wallwash - White	OPT-EF208B-WWWW	OPT-EF208C-WWWW	OPT-EF208D-WWWW
	Wallwash - Black	OPT-EF208B-WWBB	OPT-EF208C-WWBB	OPT-EF208D-WWBB
	Barn Doors - White	OPT-EF208B-BDWW	OPT-EF208C-BDWW	OPT-EF208D-BDWW
	Barn Doors - Black	OPT-EF208B-BDBB	OPT-EF208C-BDBB	OPT-EF208D-BDBB
	Diffused Lens	OPT-EF208B-P-DFL	OPT-EF208C-P-DFL	OPT-EF208D-PDFL
	Linear Spread Lens	OPT-EF208B-P-LSL	OPT-EF208C-P-LSL	OPT-EF208D-P-LSL
	Narrow Beam	OPT-EF208B-REFLN	OPT-EF208C-REFLN	OPT-EF208D-REFLN
	Medium Beam	OPT-EF208B-REFLM	OPT-EF208C-REFLM	OPT-EF208D-REFLM
	Wide Beam	OPT-EF208B-REFLW	OPT-EF208C-REFLW	OPT-EF208D-REFLW
	Very Wide Beam	OPT-EF208B-REFLV	N/A	OPT-EF208D-REFLV

PROJECT	TYPE	CATALOG NUMBER
---------	------	----------------

ELECTRICAL COMPONENTS

EFXFD
POWER STARTER FEED
 Electrical Component

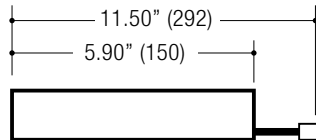

Starter Box

EFXJW
JUMPER WIRE
 Electrical Component

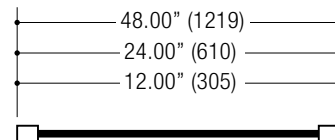

Jumper Wire

ORDERING INFO

SERIES	VOLTAGE	FINISH
EFXFD Power Starter Feed	U 5 Wire / 0-10V Capable	BB Black WW White

Ordering Example: **EFXFD-U-BB**

ORDERING INFO



SERIES	DESCRIPTION	VOLTAGE	FINISH
EFXJW Jumper Wire	012 Jumper Wire 1' 024 Jumper Wire 2' 048 Jumper Wire 4'	U 5 Wire / 0-10V Capable	BB Black WW White

Ordering Example: **EFXJW-024-U-BB**

TYPICAL COMPONENT INSTALLATION

