

| | | |
|---------|------|----------------|
| PROJECT | TYPE | CATALOG NUMBER |
|---------|------|----------------|

Measurements in () are metric equivalents.

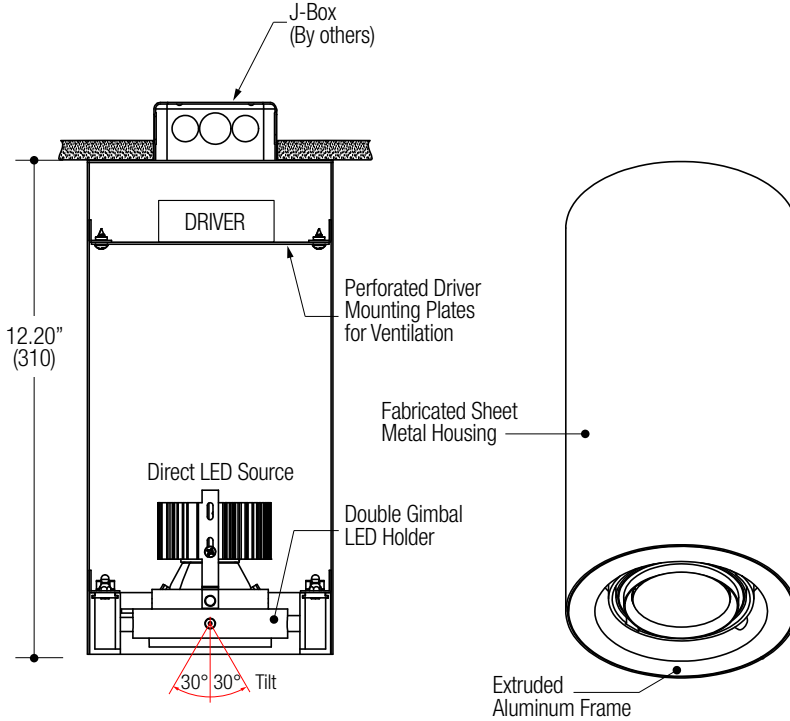

ROUND HOUSING

- Single downlight accent fixture / medium size
- 1.50" x .75" extruded aluminum frame with .188" aluminum cross blades
- Fabricated sheet metal housing
- Double gimbal lamp holder
- 30° x 30° tilt aiming

LED SOURCE

- Field-replaceable integral LED module
- Field-changeable optics
- Bridgelux or CREE - See Performance Chart
- Accepts up to 2 optical accessories

ELECTRICAL

- Field accessible junction box wiring and power supply enclosure, access from below
- Perforated / vented power supply enclosure
- Integral thermal protection
- Easy maintenance access
- Optional dimming

MOUNTING

- 2 Pendant kit options or directly to junction box

LABELS

- Suitable for damp location

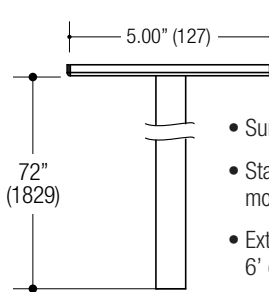
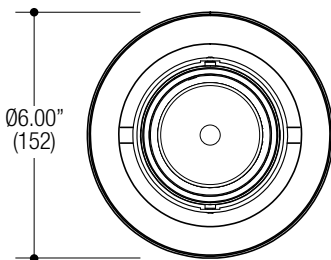

STEM Stem Kit

- Surface mount canopy
- Standard J-box surface mounting hardware
- Extruded aluminum stem 6' overall length
- Fixture mounting hardware

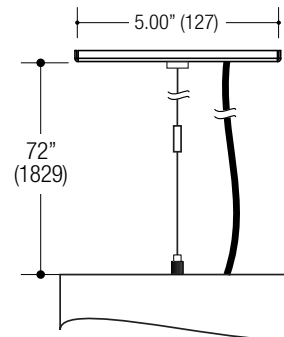



SUPL Power Supply Kit

- Surface mount canopy
- Standard J-box surface mounting hardware
- Power supply line & Safety cable 6' overall length
- Connecting hardware

ORDERING INFO

| SERIES | BRIDGELUX | CRI / COLOR | CREE | CRI / COLOR | BEAM | DRIVER | VOLTAGE | FINISH | MOUNTING | OPTIONS |
|--|-----------|-------------|------|-------------|--------|--|----------------------------|--|-------------------------------|-----------------|
| SRBRP-C CYLINDER ROUND PENDANT MOUNT Medium Double Gimbal | 17L | 8027 | 20C | 8027 | N | D1 Phase Dimming (120V only) | 1 120V U 120-277V | BB Black WW White SS Silver XX Custom | Leave blank for Surface Mount | EM Emergency |
| | 22L | 8030 | 28C | 8030 | Narrow | D2 0-10V Dimming | | | | |
| | | 8035 | | 8035 | M | D3 Lutron Hi-lume...* Forward Phase | | | | |
| | | 8040 | | 8040 | Medium | 2 wire 1% (120V only) | | | | |
| | | 9027 | | 9527 | W | D4 Lutron Hi-lume...* | | | | |
| | | 9030 | | 9530 | Wide | EcoSystem™ & 3 wire (1%) | | | | |
| | | 9727 | | 9535 | | DE Lutron Hi-lume... EcoSystem™* 1% w/Soft-On, Fade-to-Black™ | | | | |
| | 9730 | | 9540 | | | | | | | |
| REFERENCE PERFORMANCE CHART | | | | | | *Consult factory for further dimming options | | | | |
| SRBRP-C | | | | | | | | | | |

Ordering Example: **SRBRP-C-22L-8027-N-D2-U-BB-SUPL**

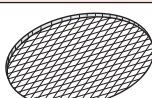
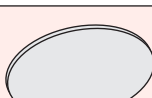
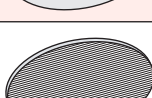
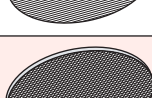
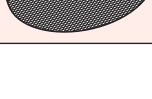
| OPTICAL ACCESSORY | DESCRIPTION | LIGHT SOURCE |
|---|---------------------------------|--------------|
| | | MEDIUM |
| | | • 70mm LED |
|  | Clear Lens | OPTC-CLR |
| | Clear Lens - LED Film | OPTC-L-CLR |
|  | UV Lens | OPTC-UVL |
|  | Hex Cell Louver | OPTC-HXL |
|  | Diffusion Lens | OPTC-DFL |
| | Diffusion Lens - LED Film | OPTC-L-DFL |
|  | Linear Spread Lens | OPTBC-LSL |
| | Linear Spread Lens - LED Film | OPTC-L-LSL |
|  | Prismatic Spread Lens | OPTC-PSL |
|  | Snoot - Black | OPTC-SNB |
| | Snoot - White | OPTC-SNW |
| | Snoot - Silver | OPTC-SNS |
| | Snoot - White With Black Splay | OPTC-SNWB |
| | Snoot - Silver With Black Splay | OPTC-SNSB |

* Other filters, colored glass, dichroics & micro-lenses available upon request

LED Performance Chart

BRIDGELUX

| WATTAGE / LUMENS | CRI / COLOR | BEAM |
|----------------------------------|---------------------------|------------|
| 17L 17W LED / 1700lm nom. | 8027 80CRI / 2700K | N |
| 22L 22W LED / 2200lm nom. | 8030 80CRI / 3000K | Narrow 22° |
| | 8035 80CRI / 3500K | M |
| | 8040 80CRI / 4000K | Medium 43° |
| | 9027 90CRI / 2700K | W |
| | 9030 90CRI / 3000K | Wide 58° |
| | 9727 97CRI / 2700K | |
| | 9730 97CRI / 3000K | |



CREE

| WATTAGE / LUMENS | CRI / COLOR | BEAM |
|----------------------------------|---------------------------|------------|
| 20C 20W LED / 1800lm nom. | 8027 80CRI / 2700K | N |
| 28C 28W LED / 2200lm nom. | 8030 80CRI / 3000K | Narrow 14° |
| | 8035 80CRI / 3500K | M |
| | 8040 80CRI / 4000K | Medium 30° |
| | 9527 95CRI / 2700K | W |
| | 9530 95CRI / 3000K | Wide 40° |
| | 9535 95CRI / 3500K | |
| | 9540 95CRI / 4000K | |

