

PROJECT	TYPE	CATALOG NUMBER
---------	------	----------------

*Shown using G, H, J, style track adapter. (See Track Adapters below)

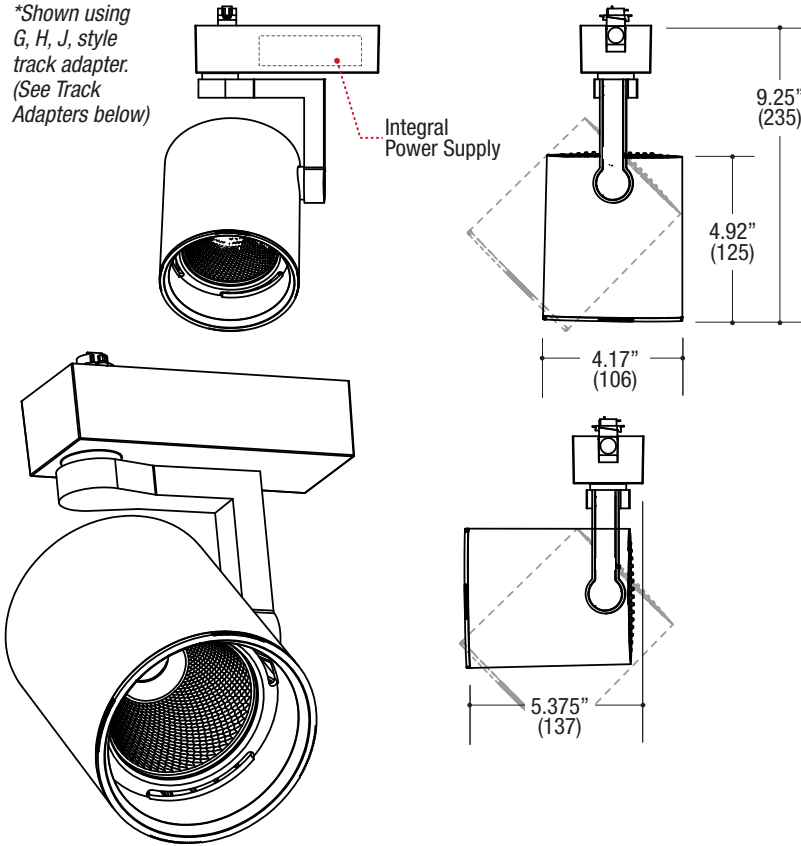

TRACKHEAD

- 4.17" diameter simple cylinder shaped trackhead
- 0° - 90° vertical tilting / 355° horizontal rotation
- Die cast aluminum head & power supply housing
- 99.98% pure aluminum anodized reflector
- Easy relamping via removable twist-lock front ring
- Powder coat finish

LED SOURCE

- Field replaceable LED
- 14W / 1300lm, 80CRI / 3000K - Passive Cooling
- 20W / 2000lm, 80CRI / 3000K - Passive Cooling
- 28W / 2500lm, 80CRI / 3000K - Passive Cooling
- 35W / 3300lm, 80CRI / 3000K - Passive Cooling
- 41W / 3900lm, 80CRI / 3000K - Passive Cooling
- 55W / 4900lm, 80CRI / 3000K - Active Cooling*
- Accepts up to 2 optical accessories

* **Note:** Active cooling required, not suitable for use in noise sensitive environments. Not recommended for residential use.

ELECTRICAL

- Integral LED driver
- Dimmable power supply available

MOUNTING

- Compatible with Halo®, Juno®, or Global® track

LABELS

- Suitable for dry location

5 YEAR WARRANTY
Limited



Power Supply Case / Track Adapter Information

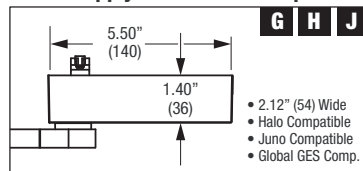

Halo® is a registered trademark of Cooper Industries.
Juno® is a registered trademark of Juno Lighting.
Global® is a registered trademark of Nordic Aluminum.

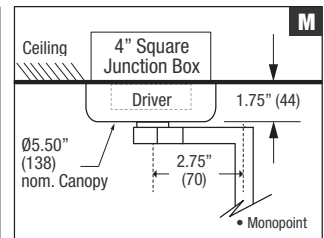
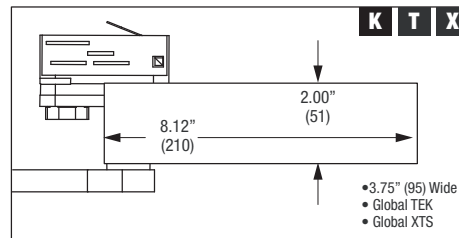

ORDERING INFO

SERIES	ADAPTER	WATTAGE	CRI / COLOR	BEAM	POWER SUPPLY	VOLTAGE	FINISH
TRA02C CADEN Cylinder Trackhead Die-Cast Aluminum Adjustable Aim	H Halo® compatible*	14C 14W LED (Passive)	8027 80CRI / 2700K	N Narrow 20°	LD LED Driver	1 120V	BB Black
	J Juno® compatible*	20C 20W LED (Passive)	8030 80CRI / 3000K	M Medium 29°	D1* Phase Dimming (120V only)	2 277V (HTEK only)	WW White
	G Global® GES compatible*	28C 28W LED (Passive)	8035 80CRI / 3500K	W Wide 40°	D2 0-10V Dim Driver (Monopoint Only)	U 120-277V (Monopoint only)	SS Silver
	T Global® TEK compatible	35C 35W LED (Passive)	8040 80CRI / 4000K				WB White housing / Black bezel
	K Global® HTEK compatible	41C 41W LED (Passive)	8050 80CRI / 5000K				
	X Global® XTS compatible	55C* 55W LED (Active)	9527 95CRI / 2700K				
	M Monopoint		9530 95CRI / 3000K				
			9535 95CRI / 3500K				
			9540 95CRI / 4000K				
			9550 95CRI / 5000K				
						* Larger power supply case may be required. Depending on wattage - Consult factory for details	

Ordering Example: **TRA02C-H-35C-8030-N-LD-1-WW**

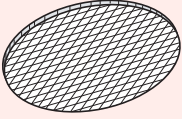
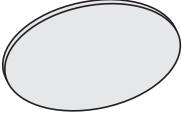
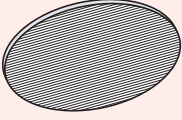
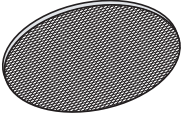
OPTICAL ACCESSORY	DESCRIPTION	TRACKHEADS			
		LANIE	JULIE	CADEN	JAMIE
	Hex Cell Louver	N/A	OPT-TRA19C-HXL	OPT-TRA02C-HXL	N/A
	Diffusion Lens	OPT-TRA20B-P-DFL	OPT-TRA19B-P-DFL	OPT-TRA02C-P-DFL	FILM ONLY OPT-TRA03B-L-DFL
	Linear Spread Lens	OPT-TRA20B-P-LSL	OPT-TRA19B-P-LSL	OPT-TRA02C-P-LSL	FILM ONLY OPT-TRA03B-L-LSL
	Prismatic Spread Lens	OPT-TRA20B-P-PSL	OPT-TRA19B-P-PSL	OPT-TRA02C-P-PSL	N/A

* Other filters, colored glass, dichroics & micro-lenses available upon request