

PROJECT	TYPE	CATALOG NUMBER
---------	------	----------------

**9122B** **SQUARE GIMBAL ADJUSTABLE TRIMLESS ACCENT** - The VF100 Series of recessed downlight and housing configurations represent the pinnacle of innovation for the architectural industry. These fixtures meet and exceed the needs of today's lighting designers and specifiers for small recessed fixtures that perform.

Measurements in ( ) are metric equivalents.

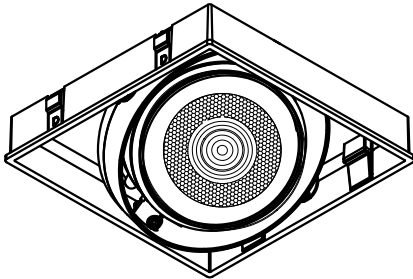

- 360° Lockable horizontal rotation
- 07S = 40° x 40° Locking vertical tilt aiming
- 10S = 33° x 33° Locking vertical tilt aiming

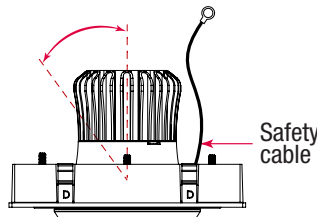

Safety cable

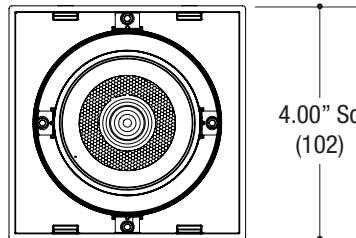

**REPLACES GIMBALO**



### Specifications

#### SQUARE DOWNLIGHT

- Recessed gimbal adjustable downlight
- 4.00" square aluminum trimless insert
- Double gimbal assembly
- Snap in spring retainers for easy trim insertion and removal
- Safety cable included
- Powder coat finish

### TRIM ORDERING INFO

TRIM SERIES	SORAA	CRI / COLOR	BEAM	TRIM FINISH
<b>9122B</b> For New Construction Housing	<b>07S</b> <b>10S</b>	<b>8027</b> 80CRI / 2700K <b>8030</b> 80CRI / 3000K <b>8040</b> 80CRI / 4000K <b>9527</b> 95CRI / 2700K <b>9530</b> 95CRI / 3000K <b>9540</b> 95CRI / 4000K	<b>N</b> Narrow 10°  Works with SORAA Snap-System	<b>MB</b> Black <b>MW</b> White <b>XX</b> Custom
<b>BULLSEYE™ SERIES</b> <b>4.00" SQUARE</b> Trimless Insert Adjustable Downlight				

Example: **9122B-10S-8030-N-MB**

**5 YEAR WARRANTY**  
Limited



## LED Performance Chart

### SORAA 2" MODULE

WATTAGE / LUMENS	CRI / COLOR
<b>07S</b> 07W LED / 650lm nom.	<b>8027</b> 80CRI / 2700K
<b>10S</b> 10W LED / 800lm nom.	<b>8030</b> 80CRI / 3000K
	<b>8040</b> 80CRI / 4000K
	<b>9527</b> 95CRI / 2700K
	<b>9530</b> 95CRI / 3000K
	<b>9540</b> 95CRI / 4000K

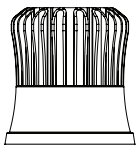

Measurements in ( ) are metric equivalents.

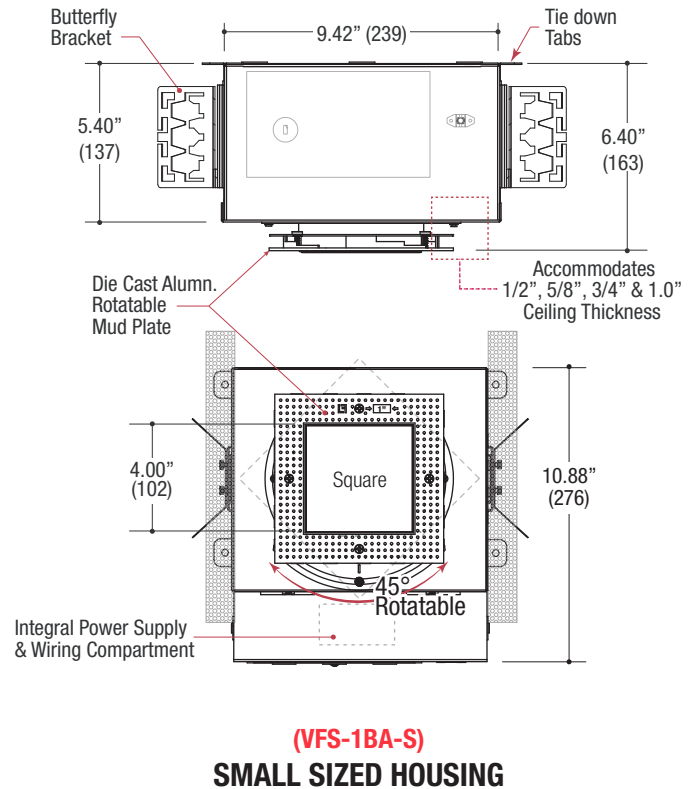
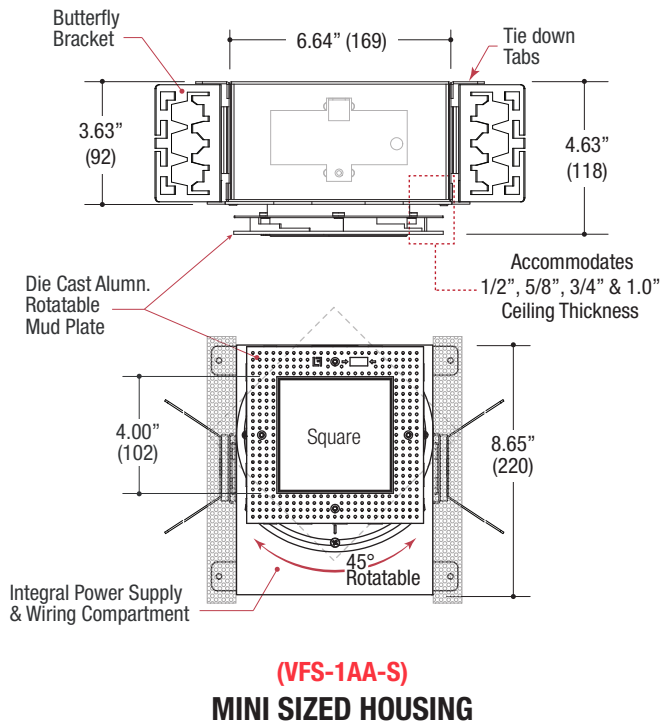

## Specifications

### SQUARE TRIMLESS HOUSING

- Housing of all steel construction
- Adjustable plaster frame
- Black powder coat finish
- **Ceiling Cut-out - 6.50" X 6.50"**

### ELECTRICAL

- Field-replaceable integral LED driver
- Electrical wiring compartment integrated into housing construction
- Internal thermal protection
- Easy maintenance access through ceiling opening
- Rated for through-branch wiring
- Optional dimming

### MOUNTING

- Butterfly brackets for commercial installation in drywall or other mud in ceiling types
- Perforated plate adjusts for 1/2", 5/8", 3/4" & 1.0" ceiling thickness
- Includes heavy-duty **L-Bars™** hanger bar system for residential installation

### LABELS









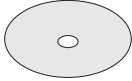

- Suitable for damp location
- **Air-Tight / IC Optional**

### HOUSING ORDERING INFO

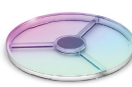

SERIES	SORAA	DRIVER	VOLTAGE	OPTIONS
<b>VFS-1AA-S</b> <b>Mini Square Trimless</b> New Construction Housing	<b>07S</b> 11W LED <b>10S</b> 16W LED	<b>D1</b> Phase Dimming (120V only) <b>D2</b> 0-10V Dimming (120-277V only) <b>D3</b> Lutron Hi-lume™* Forward Phase 2 wire 1% (120V only) <b>D4</b> Lutron Hi-lume™* EcoSystem™ & 3 wire (1%) (120-277V only) <b>DE</b> Lutron Hi-lume™ EcoSystem™* 1% w/Soft-On, Fade-to-Black™ (120-277V only)	<b>1</b> 120V <b>U</b> 120-277V	<b>IC</b> Insulated Ceiling <b>EM</b> Remotely Mounted Emergency LED Inverter
<b>VFS-1BA-S</b> <b>Small Square Trimless</b> New Construction Housing		* VFR-1BA-S small housing only		
Black finish is standard				

Ordering Example: **VFS-1BA-S-10S-D1-1-IC**

OPTICAL ACCESSORY	DESCRIPTION	07S and 10S
		SORAA SMALL 7W & 10W
		• SORAA Snap-System
	SLX16 Snap Lens Accessory Holder <i>(3 Magnetic Stand-offs Required for Bullseye 07S &amp; 10S)</i>	OPTB-SLX16-HLD
	Hex Cell Louver Louver Snap 40° Cutoff	OPTB-SLX16-HXL Ø2.00" (51mm) nom.
	Diffusion Lens LED Film	OPTB-SLX16-L-DFL Ø2.00" (51mm) nom.
	Linear Snap 10° x 25°	OPTB-SLX16-LSN Ø2.00" (51mm) nom.
	Linear Snap 10° x 36°	OPTB-SLX16-LSL Ø2.00" (51mm) nom.
	Linear Snap 10° x 60°	OPTB-SLX16-LSW Ø2.00" (51mm) nom.
	25° Beam Spreader Snap	OPTB-SLX16-MED25 Ø2.00" (51mm) nom.
	36° Beam Spreader Snap	OPTB-SLX16-WID36 Ø2.00" (51mm) nom.
	60° Beam Spreader Snap	OPTB-SLX16-VWD60 Ø2.00" (51mm) nom.
	1/4 CTO CCT Shifter Snap	OPTB-SLX16-14CTO Ø2.00" (51mm) nom.
	1/2 CTO CCT Shifter Snap	OPTB-SLX16-12CTO Ø2.00" (51mm) nom.
	3/4 CTO CCT Shifter Snap	OPTB-SLX16-34CTO Ø2.00" (51mm) nom.
	Flat Top 25° x 25°	OPTB-SLX16-FT2 Ø2.00" (51mm) nom.
	Flat Top 36° x 36°	OPTB-SLX16-FT3 Ø2.00" (51mm) nom.
	Clear Lens	OPTB-SLX16-CLR Ø2.00" (51mm) nom.
	Enhance Lens	OPTB-SLX16-ENH Ø2.00" (51mm) nom.
	Aimable Lens	OPTB-SLX16-AIM Ø2.00" (51mm) nom.